

SIMPLE Shadows



How to make a simple horizontal sun dial or ~ for the common latitudes of the planet earth. And, how and why they work.

Simon Wheaton-Smith
November, 2010



SIMPLE Shadows

TABLE OF CONTENTS

Introduction

Get Started BUILD IT FIRST AND ALSO UNDERSTAND IT

Chapter 1	The evolution of the dial
Chapter 2	How the earth and sun do their thing
Chapter 3	Determining true north since we need the polar axis
Chapter 4	Sundial construction and key points
Chapter 5	A horizontal dial and using a nomogram

Appendix

FREE Please download:-
or simpleShadows.xls for Excel
or simpleShadows.ods for Open Office
or simpleShadows.wks for MS Works

from:- www.illustratingshadows.com

or illustrating-shadows.xls for Excel
or illustrating-shadows.ods for Open Office

(c) 2005-2010 Simon Wheaton-Smith All rights reserved. However, this may be given as is for no cost beyond copying, to anyone; and selections may be copied provided credit is given to this book, author, and referenced works, and the author emailed for information purposes at: illustratingshadows@yahoo.com Please check:

www.illustratingshadows.com

regularly for articles, updates, templates, or spreadsheets. An all purpose spreadsheet covering many dialing functions is available there.

ISBN 0-9765286-5-7 ISBN13 978-0-9765286-5-4
extracted from Illustrating TIME'S Shadow

INTRODUCTION

There are a number of books on sundials, some easier to find, some harder, yet they all provide a wealth of information. From a personally biased perspective, ILLUSTRATING TIME'S SHADOW is by far the best!

I had grown up with a few sundials, and a lot of clocks. I collected clocks, and when I was a teenager I was given a portable sundial, and later I acquired some astrolabes. The house I was born in was Pilton Manor in Somerset, England. We had one sundial I had a picture of, but I was too small to be able to read it. Then in 1951 we moved to Hey Farm in Somerset also, an old house in much need of repair. In the east end of the lawn there was an old sundial. It was missing some pieces, yet together with its moss and the occasional present from a visiting bird, it was a feature of our life, and a center piece when we used to have tea or picnics on the lawn.



I built a number of sundials, some worked better than others and I found what did and did not work. In reading the books I was somewhat frustrated by geometric projections that were not always clear and took a long time to comprehend, some seemed to have some non sequiturs, and the diagrams were not on the same page as the text making it harder still. Some

even used different symbols than their associated descriptive text. Some books even appeared to be inconsistent. One book would be great at this feature, poor at another, thus I started to collect charts, tables, and methods.

Above to the left is the author's stone sundial of his youth in the 1950s .

The objective of this book is to show clearly some methods for making the horizontal sun dial for all sorts of places. Enjoy your trip to a world of sunlight.

Simon Wheaton-Smith
FRI, MBCS, CITP
Member of the North American Sundial Society, British Sundial Society

A QUICK HANDS ON PROJECT ~ ~ ~ BUILD IT FIRST – FIX IT NEXT

The next two pages offer a simple "go ahead and build it" horizontal sundial, then see what needs to be done to make it accurate. The rest of the book is the other way around, theory to understand what is going on, then build it. These two pages help you build a horizontal dial and for all readers, this is a good prelude to the rest of the book. And now, some questions...

1. What is your latitude (how far north or south are you from the equator). Many maps show this, and so does a GPS. In the appendices, Table A2.5 may help.

my latitude is:	<input style="width: 150px; height: 20px;" type="text"/>
-----------------	--

2. **EITHER** download the spreadsheet at:

www.illustratingshadows.com/reference-spreadsheets.xls

then on the worksheet named "h dial with all figures", enter the latitude. **OR** go to tables A3.1a, A3.1b, or A3.1c in the appendices, look at the latitude at the top of the columns, then find the angles for the hours you wish marked.

6	7	8	9	10	11	noon
6	5	4	3	2	1	noon

morning hours
afternoon hours

3. Mark the lines on the template "A DRAFTING SHEET FOR HORIZONTAL DIALS" from the appendices. The end result should look roughly like the fan of lines to the right.

Noon is going to be on the north south line and the 6am and 6pm lines will be at 90 degrees to that, The other lines will fan out, and their angles depend on your latitude.

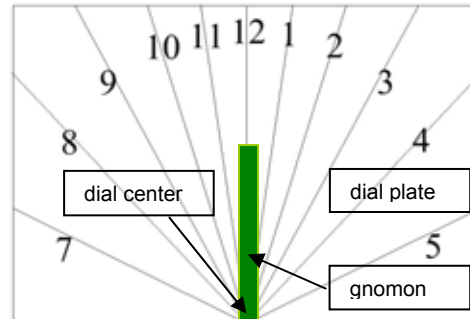

4. Transpose the hour lines to wood, PVC, copper, glass, concrete, or any other medium. This is called the dial plate.

5. Build a shadow casting device, called a gnomon, it is a triangle whose angle from the dial plate is equal to the latitude. The angle is important, the length is not, unless you want to add other information related to the time of year, discussed in the main part of the book. **NOTE:** the gnomon should be thin. If it is thick as shown above, then the am and pm hours should be separated at noon to account for it.

6. Affix the gnomon to the dial plate, the latitude angle end rests on top of where the hour lines converge (dial center), and it lies on the north south line, or the noon line.

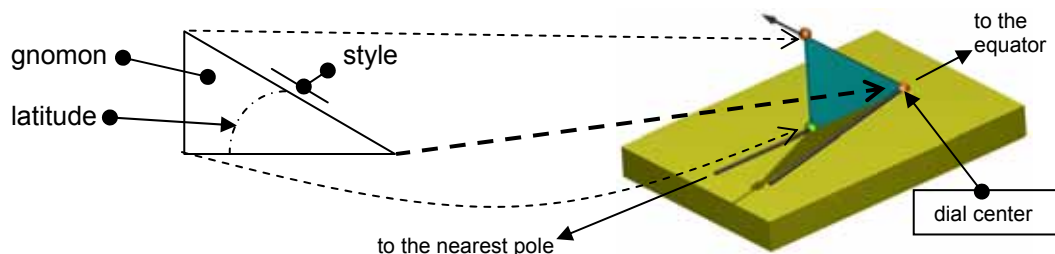

7. Take the dial plate, it's affixed gnomon on the noon line and place it in the sun.
8. Align the noon line with north/south, and the gnomon's end placed on dial center (where it meets the hour lines), should point to the equator, south in the northern hemisphere or north in the southern hemisphere.

By north, true north is meant, not the north where a compass points. To find true north, first find magnetic north by using a compass but keep away from metal.

Then find your location's magnetic variation, or declination as sun dial people call it. If it is an easterly declination you must back away from north to the west. If it is a westerly declination, you must back away from north to the east. Magnetic declinations are often found on maps, and a table and a map in the appendix has declination information.

my magnetic declination:	E
	W

Table A2.5 and the maps in appendix 2 may help, and many websites also, you may try:
<http://www.magnetic-declination.com/>

9. With the dial plate level, the angled part of the gnomon pointing north south, the dial will now read sun-time, or local-apparent-time or LAT for short. It is still not clock accurate. There are **two corrections** to make. One is to correct for your distance from your time zone's reference **longitude**, the other is for the fact the sun is predictably slow or fast (compared to man made watches) as the year progresses, this correction is called the **equation of time or EOT for short**.
10. Find your **longitude**, it is on your GPS unit, or on a map of your area. Aviation and geological survey maps work, but road maps may not. Once you know your longitude, and your time zone, find your time zone's reference longitude.

my longitude is:		} Table A2.5 in the appendices may help.
my time zone reference is:		
difference between the two is:		← Table A2.6 in the appendices may help.
		→ times 4 is: _____ minutes

If your longitude is larger than the reference longitude, then ADD the difference times 4, this is the minutes to add to correct for your location.

If your longitude is smaller than the reference longitude, then SUBTRACT the difference times 4, this is the minutes to add to correct for your location.

plus [] or minus [] ___ minutes to correct for location.
--

11. We now have a dial built for your latitude, aligned north/south, and corrected for your location's distance from the time zone's reference longitude. However it may still be off by plus or minus up to 16 minutes due to the fact the sun's orbit around the earth varies as the year progresses, and the sun similarly moves north or south of the equator. There is a table of corrections for this **equation of time or EOT**, table A2.1 is by the day.
12. That is it! You now have a working horizontal sun dial. To delve into it more, read on

CHAPTER 1

THE EVOLUTION OF THE DIAL

USEFUL DEFINITIONS –

- The EOT, or equation of time is the difference between the real apparent sun and a virtual perfectly on-time sun that matches the modern "accurate" clock
- Altitude – how high above the horizon the sun is, measured in degrees.
- Azimuth ~ how far east or west of the north-south line the sun is, measured in degrees.

Since the earliest days of the human race, it was important to know when to plant, when to hunt, and a calendar was needed and developed. The sun's angle in the sky compared to the horizon, is its altitude, and early Egyptians employed such dials.

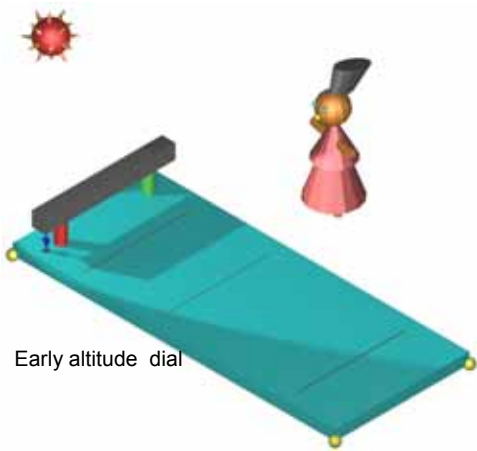

Early altitude dial

The sun woke up and climbed, ran out of energy in mid day, and becoming tired, descended into the arms of Morpheus. The early Egyptians built a simple dial that could be turned toward the sun, and its angle at mid day cast a shadow of decreasing length as the climate became warmer. Alignment with true north or south was not needed for these altitude measuring dials, since the reference was the sun, and the horizon.

For all altitude dials, north south alignment is not used but the date must be known if the one is to tell the time.

the azimuth of the sun, its angle compared with true north or south. Such early dials often divided daylight into pieces, yet those pieces were not always of equal duration, sometimes they were just arbitrary divisions. Azimuth dials do not require a gnomon of a calculated height. The line of the shadow aligns with hour lines, or points to hour points.

Of course time, altitude, and azimuth are all somewhat related. And a definitive study of dial history may not show such a sequenced development because different areas of the world evolved differently. As the horse and carriage produced rapid transportation, people needed common time keeping, and equal hours. So was ushered in the perfected sundial. That perfected dial used the angle the sun makes as it appears to orbit around the earth's north-south polar axis.

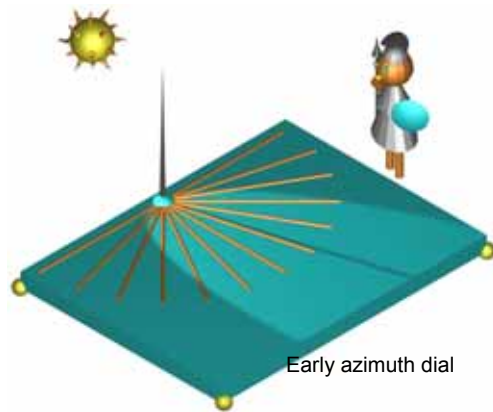

Early azimuth dial

The reader may have noticed that the sun runs slow or fast depending on the day of the year.

Sun dials use the solar position as the basis for date and for time. The earth orbits the sun, however not by an exact number of days, and even those days vary in an annual cycle. So even city slicker watches are not synchronized as well as we might think. Is the synchronization with the daily rotation of the earth, the annual rotation around the sun, or with the fixed stars?

CHAPTER 2

HOW THE EARTH AND SUN DO THEIR THING

The earth is a planet and from history we know it orbits the sun. Back in medieval times the sun rotated around the earth. Galileo and others nearly got burned at the stake when they said it was the other way round, however it is pretty much accepted that the earth moves around the sun, and by the way, the earth is no longer flat either, it is a sphere in space.

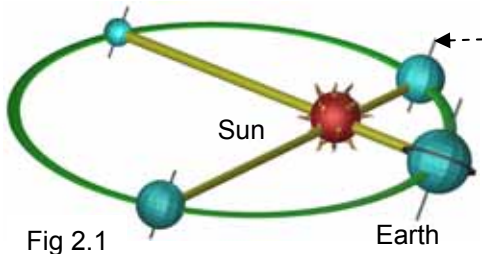

The polar axis is what the earth's surface spins around, or in essence, around which the sun apparently rotates. And we call the line running around the middle of the earth, the equator, which is perpendicular to the polar axis.

The blue thing we live on is planet earth, and what is more it is tilted. That is why the seasons vary, and it has a polar axis, and an equator which is at 90 degrees to that axis. The axis is what the earth's surface spins around. That axis is tilted about 23.5° and, looking at figure 2.2, when the sun is below the equator (bottom left in the figure below), the southern hemisphere enjoys summer, and when the sun above the equator (top right in the figure below), winter prevails down under, and summer returns to the northern hemisphere. The earth orbits the sun in an ellipse called the ecliptic, and that together with the earth's tilt, is why day length varies, and why the sun's hours vary somewhat, and hence why the equation of time was developed which corrects the sun for being slow or fast when compared to the watches and clocks. The ecliptic is 23.5 degrees off from the earth's equator.

The pictorial below shows the earth spinning on its axis, and the sun in four different positions.

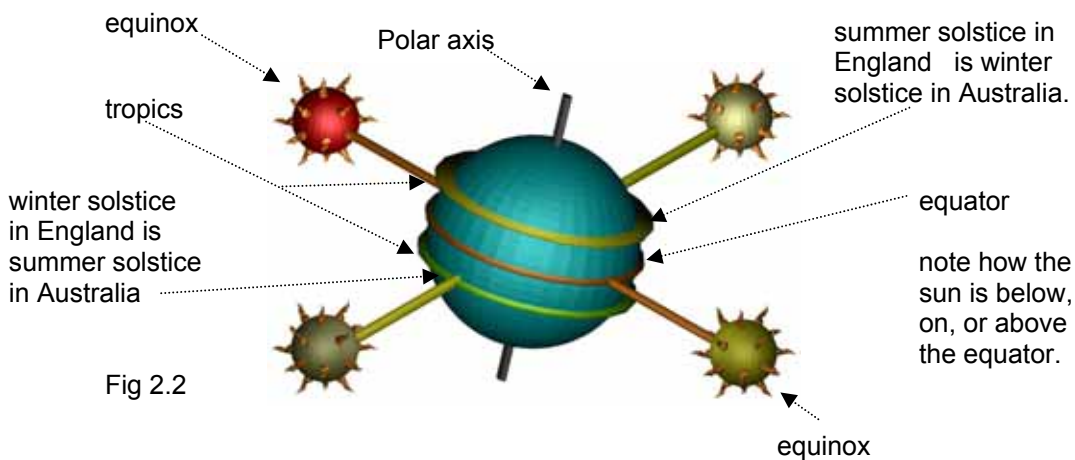

When the sun is directly in front, or directly behind the earth in the picture above, it is the equinox, and the days are equal to the nights in duration. By the way, every day on the equator is an equinox, their days are the same length as their nights. While the earth rotates around the sun, to a sundial it is as if the sun goes around the earth's polar axis, so sometimes we will assume it is before the days Galileo! Whatever works. It is all relative anyway.

Now let us define a few things that are needed in order to understand location on planet earth. The pole around which the earth spins is tilted by about 23.5° and perpendicular to it is the plane called the equator, see figure 2.3.

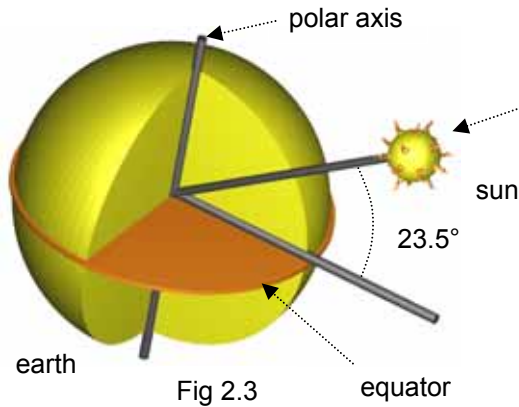

By the way, if the earth looks bigger than the sun, it is because the sun looks small to us here on planet earth, and the earth looks big to us.

Referring to figure 2.4, as a convenience, the earth is sliced up into sections parallel to the equator, and those slices are measured by their angle to the center of the earth. Those angles are called latitude and \emptyset is its common symbol.

The latitude tells you how far north or south of the equator you are. It is measured in degrees, the equator's latitude is 0° while the north pole is 90° , and one degree of latitude is about 60 nautical miles on the surface, that is how nautical miles came into being.

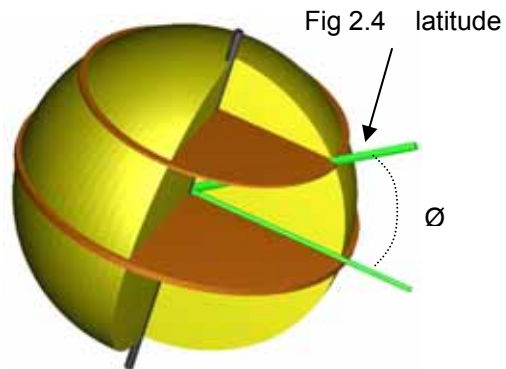

But how do you know where you are left or right on the planet. The equator is an obvious slice for latitude references, as it is 90° to the polar axis, but there is no such obvious place for the left-right position, so England graciously agreed to defined Greenwich as the reference point.

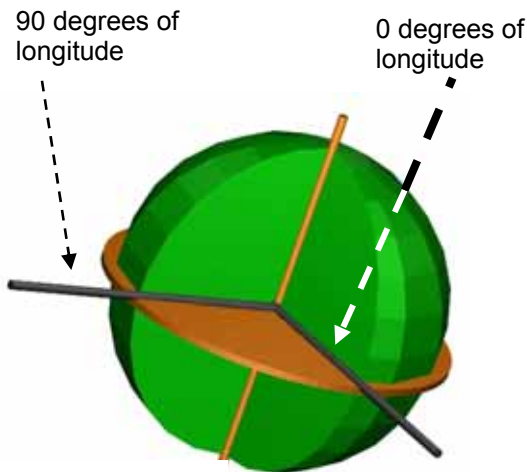

Referring to figure 2.5, longitude tells how far you are east or west of Greenwich England. However as you go further north or south of the equator, the distance between one longitude degree varies. Whereas a degree of latitude is 60 nautical miles anywhere, for longitude the distance gets smaller as you travel north or south of the equator.

Longitude does have one fixed distance relationship, however, one degree of longitude always accounts for 4 minutes of time in the motion of the sun.

Positions on the planet are identified by latitude (north or south of the equator), and by longitude (east or west of Greenwich England). Because the earth rotates on its axis, some places see the sun later and some earlier. As there are 24 hours in a day, and there are 360 degrees of longitude, 15 degrees equates to one hour, so standard longitudes are established every 15 degrees, but for political reasons they may zigzag around the place. Those longitudes in essence define legal standard time.

Those 15 degrees are split in half for those legal time zones, thus Greenwich is 0° of longitude, and 7.5° west to 7.5° east marks the legal time zone. Lets put this into the real world.

Silver City SVC	32.75° N	108.2° W	mag var	10.6° E
			mst is at 105°	SVC is 3.2 from mst
			i.e.	12 mins 48 secs from mst
Phoenix PHX	33.5° N	112.0° W	mag var	11.8° E
			mst is at 105°	PHX is 7.0° from mst
			i.e.	28 minutes from mst
Scottsdale SDL	33.6° N	111.9° W	mag var	11.8° E
			mst is at 105°	SDL is 6.9° from mst
			i.e.	27 mins 36 seconds from mst

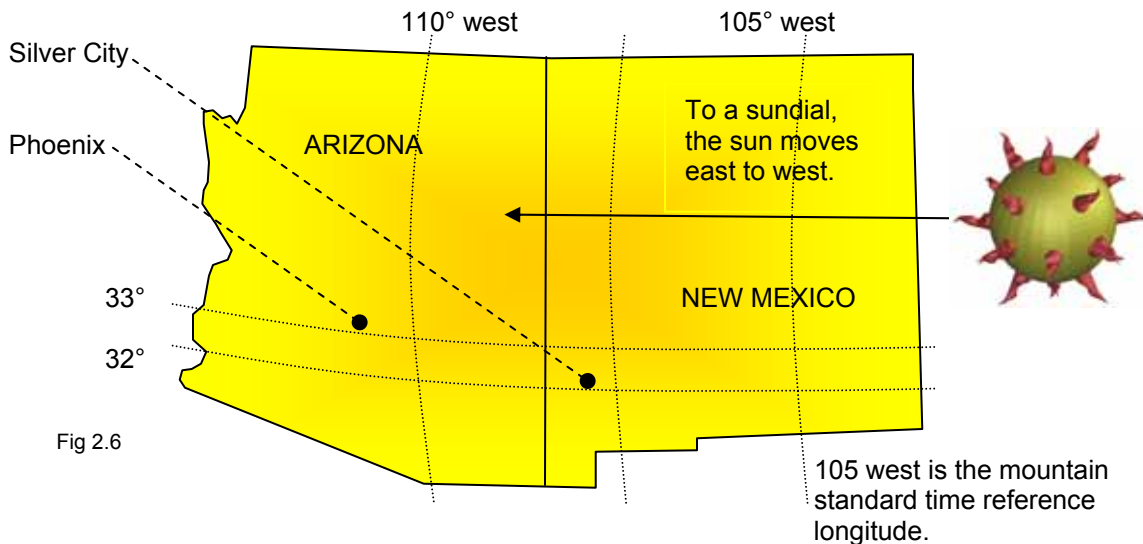

Things of interest to note are that when it is solar noon sun time on the 105 meridian (local apparent time or LAT), it will be appear earlier in Silver City and earlier still in Phoenix as far as sun time goes. Indicated sun time is called local apparent time, or LAT.

When it is solar noon on the Silver City meridian, LAT (local apparent time) it is later at the 105 meridian and earlier on the 112 meridian of Phoenix, sun time wise.

One degree of longitude is 4 minutes of LAT difference, which derives from the fact there are 360° going around the entire planet and there are 24 hours in the day or 1440 minutes.

The earth slows down and speeds up its rotation *around the sun* depending on whether the earth is further away from or nearer to the sun, and which way it is going. This means that sometimes the sun appears to be fast, and sometimes slow. Since hours nowadays are of equal length, dialists came up with a fictitious sun that were it to exist, would show perfect time. This "mean sun" differs from the real or actual sun by what is called "the equation of time", or EOT.

If the sun is fast, we subtract a correction, if the sun is slow, we add a correction. Some tables show "+" for fast meaning you "-" subtract the correction. And conversely show "-" if the sun is slow, meaning you "+" the correction. And some tables show the "-" or "+" directly so you always add the EOT value to local sun time to get the real mean time. Be wary of the sign, check it out.

Local Apparent Time (LAT) is solar time shown by the real sun at a particular place, the kind of time most sundials show. It needs two corrections before legal standard time is known.

One correction is the differences in longitude that affect the displayed time. Another correction is that measuring time using the real sun results in days of varying length. Instead of the real sun, we use an imaginary mean sun that moves at a constant speed equal to the average annual speed of the real sun. Thus we need to correct the real sun compared to the virtual or mean sun. That virtual sun, by the way, matches our clocks.

Mean Solar Time is a measure based on the virtual mean fictitious sun, it assumes that the earth's rate of rotation is constant. If you start real sun and the mean sun at a time when they coincide, over the next 12 months the mean sun will sometimes lag, sometimes lead the real sun, however at the end of the year they be back in synch.

Local Mean Time (LMT) is solar time corrected for the Equation of Time but not for longitude, which is why it is called "local". The difference between the Local Mean Time and the Local Apparent time is known as the Equation of Time.

The Equation of Time (EOT) is the time difference between Local Apparent Time (apparent solar time) and Mean Solar Time at the same place. It varies between about +14 minutes in February and -16 minutes in October. The preferred usage by sundial enthusiasts is:

$$\begin{aligned} \text{Mean Solar Time} &= \text{Apparent Solar Time} + \text{EOT} \\ \text{Standard legal time} &= \text{Mean Solar Time} + \text{longitude correction} \end{aligned}$$

This EOT sign convention is not standard and the opposite sign is used in some almanacs and web sites. Ignoring the sign convention used, the dial appears slow compared to the mean time in February, and fast in October/November. So in October you subtract an EOT number as the real sun is fast. In February you add an EOT number because the real sun is slow. EOT varies every second but is normally shown for noon each day. Mean Solar Time and the Apparent Solar Time match four times a year, i.e., the EOT is zero. The leap and the other three years are often averaged into the EOT tables, hence why key EOT dates seem inconsistent.

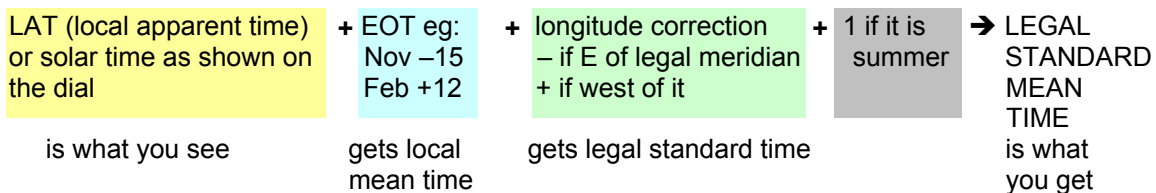

There is a software program called SHADOWS which can be used to double check sundial designs. It has a simulator feature that will show you the shadow moving, you can set it to any day and time. It has several displays of the equation of time, one is the figure of eight, one is the time lined graph, and another is a table. Here is my version of the figure of eight EOT.

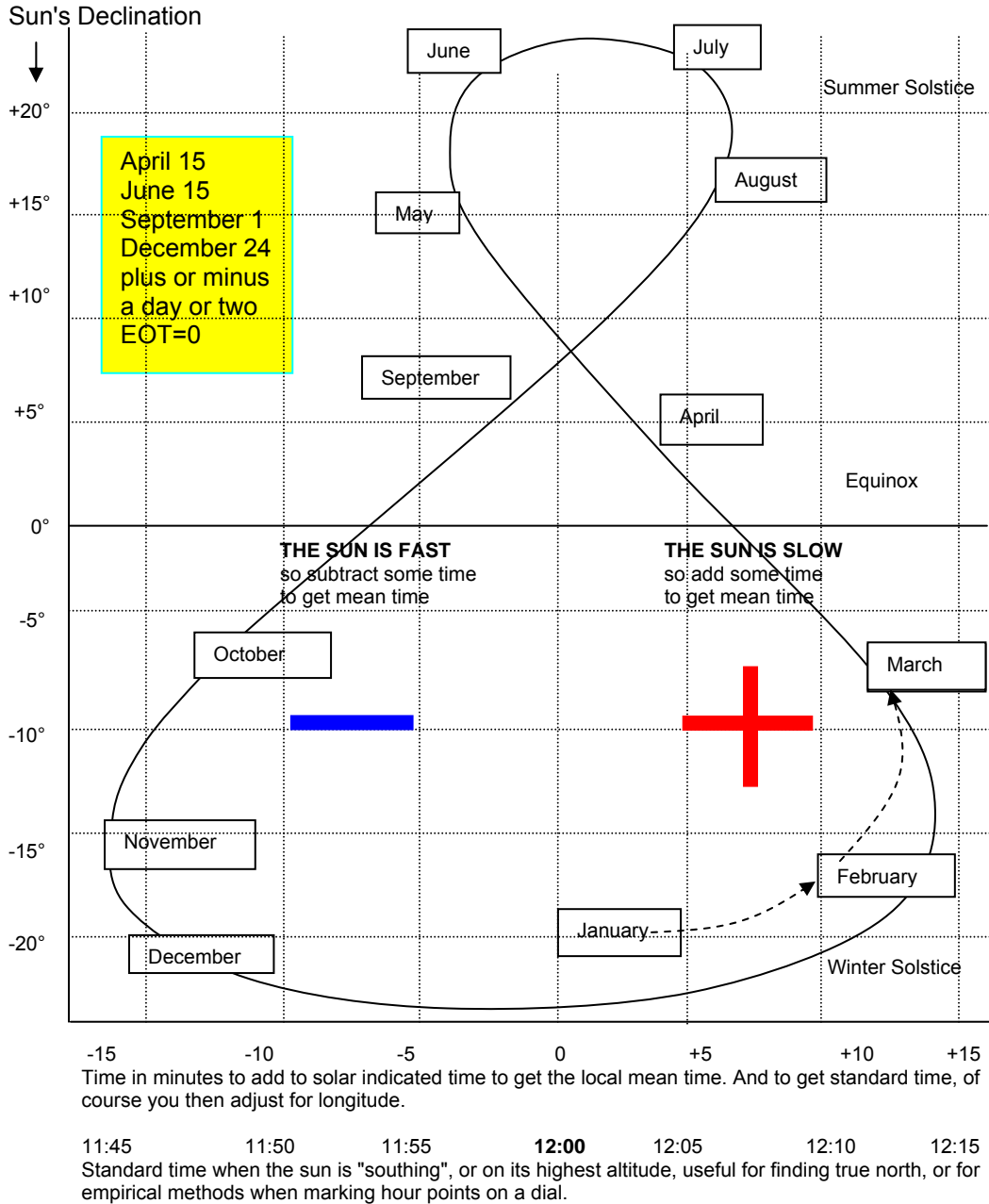

Don't forget that for sundials to be accurate, longitude must be considered in addition to the equation of time, the longitude correction is a fixed number for a given place.

Sometimes the figure of eight chart may be seen on the hour lines of a sundial, this is called an analemma and is intended to provide graphical equation of time correction. It's presence can however make a dial look rather confusing.

In reviewing the sun's motion, the earth rotates on its own axis and the earth itself rotates around the sun, to the dialist we can consider that the sun rotates around the polar axis of the earth.

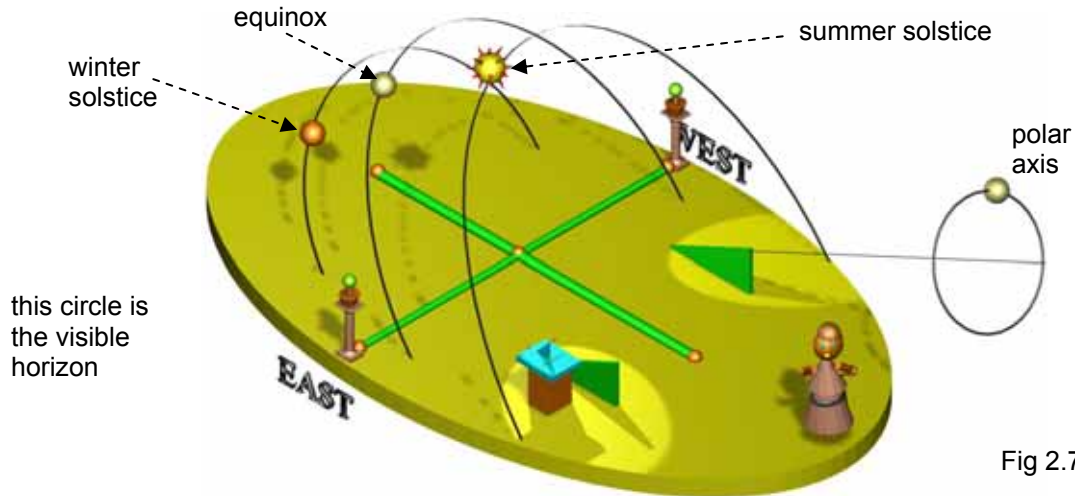

The gnomon's shadow producing edge (called style) for hour angle dials should point to true north and be parallel to the earth's polar axis. For altitude and azimuth dials, this is not relevant. From the picture above, it can now be seen that there is a simple geometrical relationship between the sun's motion around the earth, and the angles produced between the gnomon's style and also the sun's shadow. That geometry is for the most part simple and from that geometry comes the trigonometric method as an alternative method for building sundials.

Figure 2.7 shows a two gnomons, one east and one west, and why the shadow differs depending on location. This is the basis of longitude correction. One degree of longitude results in a 4 minute difference, this is because 24 hours times 60 minutes divided by the 360 degrees around the earth results in one degree for every four minutes.

As the sun gets closer to the earth on some days and further away on others caused by the elliptic as opposed to circular orbit, you can imagine that the shadow must change for the exact same time on those different days. This is corrected easily with the equation of time, or EOT.

Another correction is the daylight saving time, a political folly discussed earlier.

Figure 2.7 translates into simple geometry, discussed later, for dials that are horizontal or vertical facing true south or north, meridian dials (vertical facing true east or west), polar dials whose dial plate as well as their style are parallel to the earth's polar axis, and equatorial dials whose dial plate parallels the equator. There are all sorts of hybrids and variations in between, and they also use the sun's "hour angle", the angle the sun makes as it goes around the earth's polar axis.

Some dials use the sun's altitude, how high up it is, and not its hour angle, so they don't need alignment with true north. These tend to be less accurate than hour angle dials.

Some dials use the sun's azimuth, how far east or west the sun is of the noon day shadow. Azimuth dials don't need a gnomon of an accurate length. These tend to be less accurate than hour angle dials.

LONGITUDE AND EQUATION OF TIME CORRECTIONS ARE NEEDED

The equation of time with the longitude correction see several typical uses. The most common use is when reading a sundial, the less common uses are when building one. Remembering:-

LAT local apparent time, time indicated by a sundial (sometimes also called true time)

EOT equation of time for the day, if the sun is fast compared to a clock (or the virtual or mean sun), then there is a minus correction, and if slow, there is a plus. Some tables show fast as plus, slow as minus. They are not wrong, they are designed by people who while otherwise normal, use a different convention. Many astronomers fall into this category.

Converting local apparent time to standard time is used when reading a dial:-

$$\text{legal time or standard time or clock time} = \text{LAT} + \left\{ \begin{array}{l} \text{EOT.corr} \\ \text{eg Nov } -15 \\ \text{eg Feb } +12 \end{array} \right\} + \left\{ \begin{array}{l} + \text{ west.long.corr} \\ - \text{ east.long.corr} \end{array} \right\} + \left\{ \begin{array}{l} + 1 \text{ if} \\ \text{summer} \end{array} \right\}$$

add if west of standard meridian
 subtract if east of standard meridian

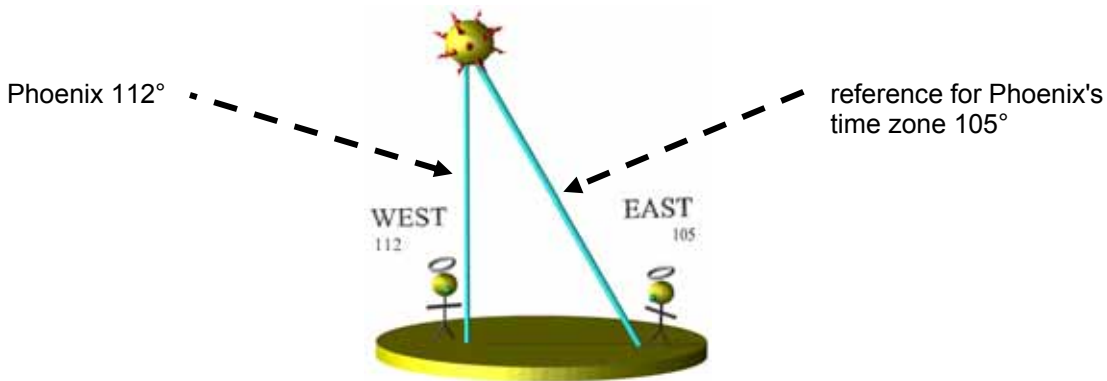

Phoenix AZ is at a longitude of 112° and is west of the standard time meridian for Phoenix covering Phoenix time which is at 105°. When reading a dial with no built-in longitude correction in Phoenix, the longitude correction must be added because it is later at the 105° standard time longitude than in Phoenix at 112°. In other words, if west then add the longitude difference times 4 minutes per degree. If east you subtract.

Since Phoenix is 7° west of the reference longitude, being 112 minus 105, and remembering one degree equates to 4 minutes, that makes Phoenix show four times seven, or 28 minutes earlier than the legal time, so you add those 28 minutes.

For purposes of repetitive learning, all of October, November, and May the sun is fast so the EOT is negative, and in all of January, February, March, July, and August the sun is slow so the EOT is positive. There are four days when the EOT is effectively zero, they are somewhere near April 15, June 15, September 1, and December 25. The extreme values of the EOT are around February 11th when the sun is slow and the EOT is +14 minutes 12 seconds, and early November when it is fast and the EOT is now - 16 minutes 22 seconds. Other peak values are near May 13th and 14th when the sun is fast, so the EOT is -3 minutes 39 seconds, and July 25th and 26th when the sun is slow with an EOT of +6 minutes 30 seconds.

THE EARTH AND SUN INTERACT - EQUINOXES AND SOLSTICES

On the equator, at 0 degrees of latitude, every day is an equinox, that is to say that every day of the year has equal hours for day and night, regardless of whether the sun is overhead, or north or south of the equator. In the three pictures below the dashed arrow shows the earth's rotation. The pictures show the earth rotating on its axis, they suggest the earth tilts back and forth yearly. In fact the earth doesn't tilt back and forth as shown during the year, it only appears to do that because the earth retains its axis as it orbits around the sun, and that orbit around the sun is what causes the sun to appear to move above and below the equator.

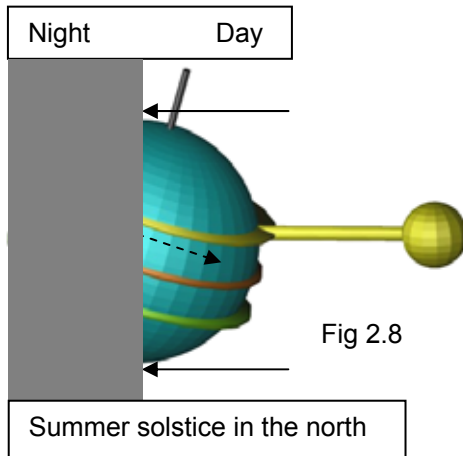

Looking at figure 2.8 the picture depicts summer in the northern hemisphere when the sun is north of the equator. As the sun's rays are parallel, the equatorial ray in the picture gets to travel the great circle around the equator. Because each place on the equator gets that ray, days and nights are of equal length. With northern visits of the sun, the sun always shines on the arctic, so the arctic has days with no night, and the bottom ray misses out on the Antarctic whose nights are dark, with no sun.

Figure 2.9 shows summer in the south, the Arctic is in permanent night, the Antarctic in permanent day, and the rays hitting the equator travel the great circle, so the equator still has days and nights of equal length.

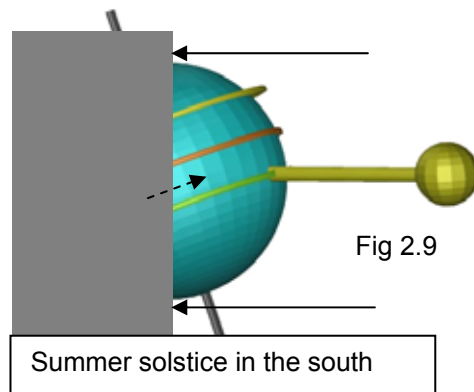
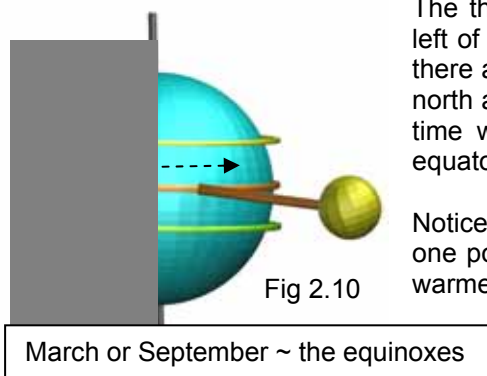

Figure 2.10 shows March and September, when everywhere on earth has days equal to nights. The equinox happens around March 21 and September 21, plus or minus a few days. The extremes of the sun moving north and south of the equator by 23.5 degrees are the solstices, December and June 21, shown in figures 3.4 and 3.5 respectively.



The three figures have a line 90 degrees to the sun's rays, left of it is dark night time, right is bright day time. Assuming there are no clouds. The equator is always bisected, it is the north and south hemispheres that have an uneven division of time when the sun is not directly above the equator. The equator is a permanent equinox.

Notice the arrows in the summer pictures, they show how one pole endures a long night time, while the other basks in warmer temperatures.

To correct a sundial reading to find legal time, add something called the EOT (equation of time) to the indicated or local apparent time (LAT). The EOT is the difference between the real sun and a fictitious but constant sun (see next chapter). If the EOT is +5, then add 5 minutes to the dial's indication because the sun is slow . If the EOT were -3, you would subtract 3 minutes (add the minus 3 means subtract 3) from the reading because the sun is fast.

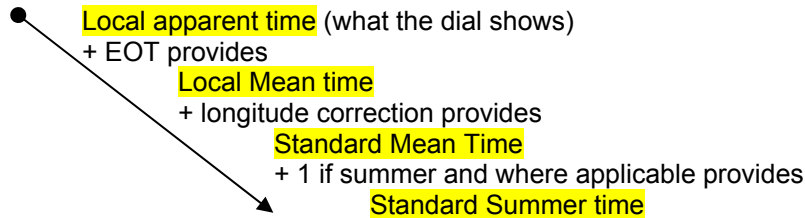

A caution: some almanacs show the equation of time with opposite signs to those used here. To a dialist, a minus means the sun is running fast and needs the minus to "slow it down". To an astronomer, a minus means the sun is "slow" or "minus" and thus needs a plus to correct it. Neither is right, neither is wrong, it is just that astronomers and dialists have different perspectives.

In summary... The earth orbits the sun, its orbit is not circular but elliptical. That orbit, and the tilt of the earth cause the sun's apparent rotation around the earth to vary throughout the year. This is corrected with the equation of time, or EOT.

Latitude defines how north or south a place is compared to the equator. Longitude defines how far east or west a place is compared to a standard reference, which happens to be in Greenwich, England.

Time as shown by a dial is corrected for the slow or fast sun, then for longitude, and finally for summer time if appropriate.

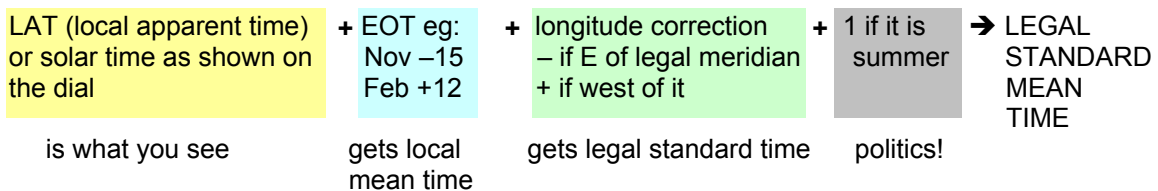

CHAPTER 3

DETERMINING TRUE NORTH SINCE WE NEED THE POLAR AXIS

There are several methods of finding out where true north lies, and each has opportunities to screw it up. Some things to consider are that true north is usually not the same as magnetic north which varies over the years. Magnetic compasses are disturbed by local minerals, rebar in concrete block walls and proximity to automobiles; however the process is instant. The sun can give us the direction for true north, is not disturbed by local magnetic fields but the method takes either time or arithmetic, and no clouds. Surveys may have mistakes in them, be old and out of date. Stars require you to be able to identify them, and there are lots of them up there!

LOCAL SURVEY MAP METHOD

Some houses have survey maps drawn showing true north for buildings on the estate. These maps are often stylistic maps and layouts, so bearings are not that accurate.

MAGNETIC COMPASS METHOD

Acquire a compass and set it level, sight the surface upon which the dial and gnomon will be affixed, then note the magnetic bearing. Avoid being close to metal such as a car, a metal garage door, or a block wall which may have rebar.

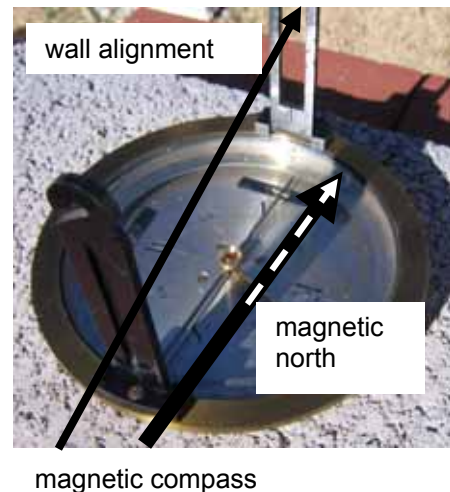
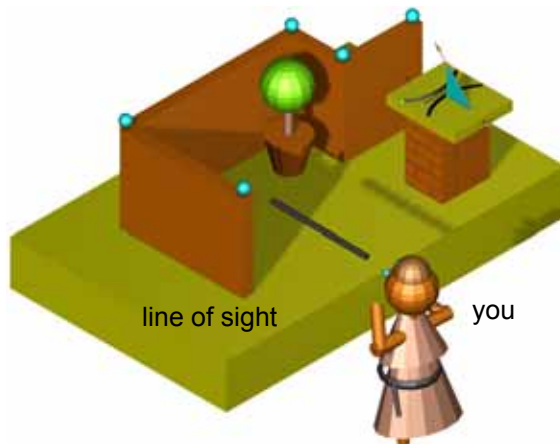

Using this surveyor's compass, the sight by definition was 0 degrees, and the magnetic needle at this location showed 6 degrees to magnetic north. So the wall must be 6 degrees west of magnetic north, or 354 degrees magnetic. Then find the magnetic declination or variation, in Phoenix it is about 11 degrees east of true north, and then make an adjustment. An easterly magnetic declination means true bearings are more than magnetic ones, and westerly declinations means true bearings are less than the magnetic bearings. Thus for an 11 degree easterly variation, 354 degrees magnetic becomes 365 true, or subtracting 360 degrees, the wall is aligned at 5 degrees true. The wall declination is used for surfaces not aligned to true north, or true south, the convention is "The declination is named for the direction we face with our back to the wall". Thus making the wall above "north 85 degrees west".

Magnetic variation is printed on most maps, and is published in almanacs and available on the web. Web sites are found by searching on "magnetic north variation" and one of several examples might be:-

http://www.geolab.nrcan.gc.ca/geomag/home_e.shtml

SOLAR METHOD ~ THE SUN CROSSES AN ARC BOTH AM AND PM



The compass method uses simple math, a compass and is quick, but the compass can be swayed by nearby metal, such as wall reinforcements, and it is easy to make a mistake in the math unless you draw pictures (see the appendix).

The solar method is slow, and requires a level surface. To the left is a photo of a dial plate with a vertical pin, except circles are drawn around the pin. The surface is leveled with bits of wood between the upturned bucket and the dial plate. The compass is not used except as a rough and

ready quick start to get the dial plate roughly pointing in the right general direction.

You begin before lunch, and note when the sun's shadow crosses an arc. And you come back in the afternoon and see when it crosses it again.

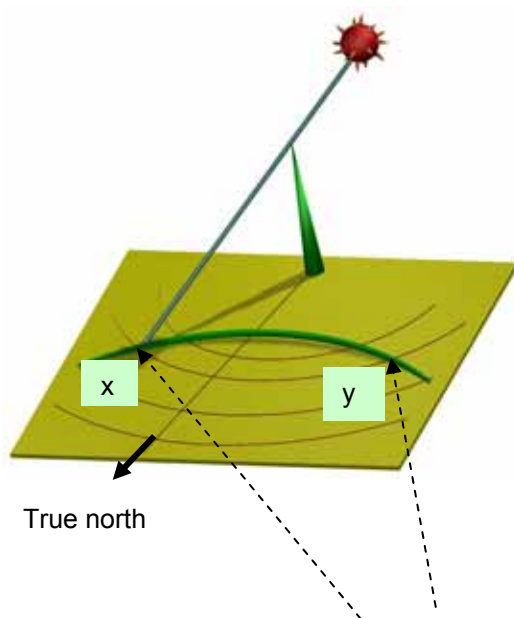

The sun crosses the circle at x and y. You draw a line from the center to x and to y, then bisect the angle. The bisected arc's center points to true north. The equation of time has nothing to do with this as it doesn't matter if the sun is slow today or fast. The sun orbits around the earth's polar axis and that is what is actually being measured, not the time. In reality you do several circles and average the results, and several circles reduces the chances of a cloud shadowing things and ruining your afternoon.

SOLAR METHOD – WHEN THE SUN IS EXACTLY AT SOLAR NOON

The longitude, equation of time, and summer time corrections for converting local apparent time into to legal standard can be used to identify true north.

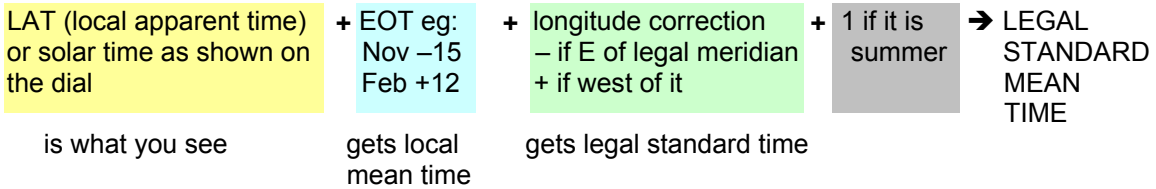

Solar noon indicates true north because the sun is at its highest point. Thus the shadow produced at solar noon will point to true north. Solar noon happens at the standard time adjusted as follows:-

$$\text{12:00:00} + \text{EOT} + \text{1 (if summer)} + \text{longitude correction} = \text{legal time for solar noon}$$

Silver City is longitude 108.2 west, and is thus 12m 48 seconds west of the meridian of 105 degrees. So to find the legal time for when the sun is at high noon, we add 12m 48s (we are west of the meridian), thus get 12:12:48 on the clock for a Silver City high solar noon. That takes care of the longitude correction. However we must correct for a slow or fast sun.

And on November 12 the equation of time shows the correction to be "-15:46" which is minus because the sun is running fast by 15 minutes and 46 seconds. We subtract the 15:46 correction so our time catches up with the sun.

radio noon on the 105 degree meridian:		12:00:00		
longitude correction:	+	00:12:48		if we are west then add
result	=	12:12:48		
equation of time correction	-	00:15:46		use EOT table's sign
result	=	11:57:02		

Some more examples:-

hour point	+	EOT	➔	legal time to make the observation
12:00	+	- 8	➔	11:52 (e.g. December 8)
12:00	+	+13	➔	12:13 (e.g. February 15)

You may think that using the rules of arithmetic, the EOT sign should be reversed. It is not reversed in the method above since no formula elements are switching sides which is why the formulae were laid out above as they are.

Time when the sun will be on the standard noon meridian

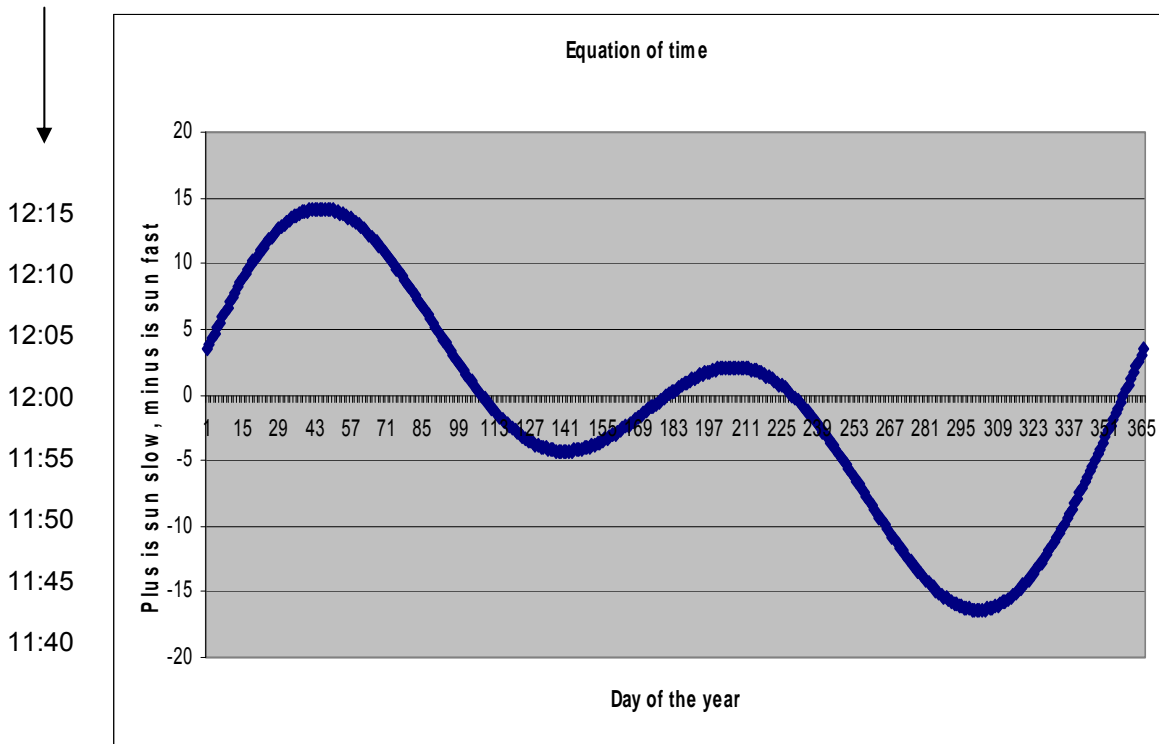

The beauty of the equation of time and its associated formula is that the techniques discussed in this book do not involve reversing the signs of the EOT, nor reversing the signs of the longitude correction.

There are two caveats when using this method to locate true north.

The first is that is that the equation of time is not fixed that accurately. First, the tables provided in this book are averages over a four year period. And over the decades, centuries, and millennia, the equation does change. The moral of the story is that the dialist should ascertain the equation of time as accurately as possible. Web sites have online almanacs for just this purpose, however be aware that many astronomical web sites show a "+" meaning sun is fast, and a – meaning sun is slow, in which case the sign must be corrected for the sun dial convention which is + for a slow sun because the EOT value must be added. Those web sites are not wrong, but check the sign before using the standard sundial EOT convention.

The second is that longitude is significant. For example, the time in seconds between the east end of runway 8 at Phoenix Sky Harbor International Airport, and the west end is 10 seconds. And 13.5 miles is one minute. A city that is 50 miles across will have a local apparent time difference of 3.75 minutes.

Accuracy in longitude and accuracy in the precise equation of time are as critical in this method, as is the accuracy of the clock employed.

CHAPTER 4

SUNDIAL CONSTRUCTION AND KEY POINTS

Below is a horizontal dial layout. They have a dial plate upon which things are inscribed or placed, such as hour lines, declination lines and so on, called furniture.

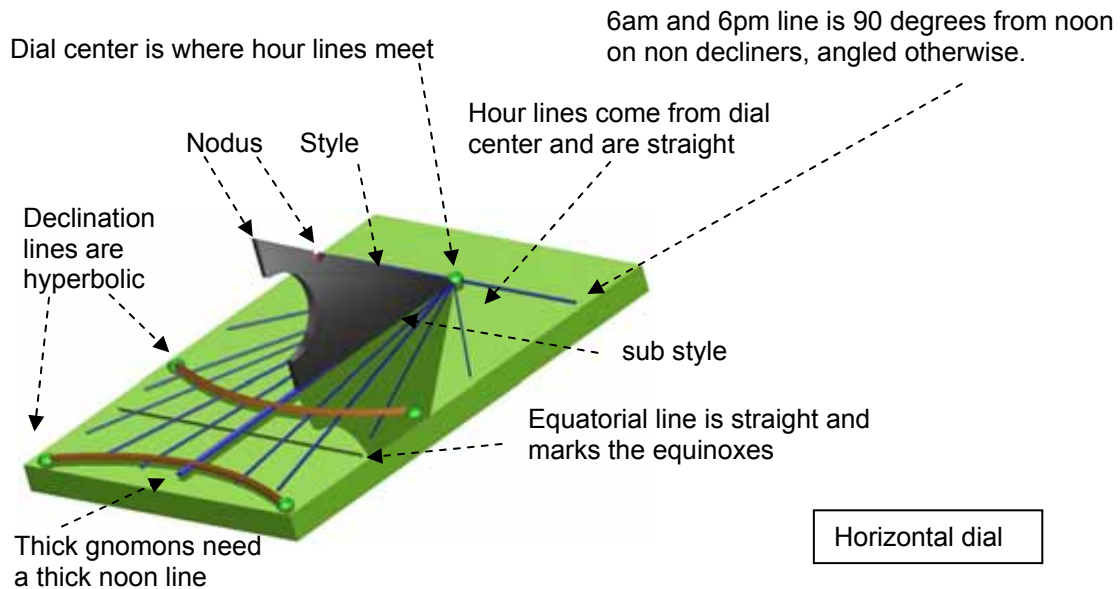

The shadow casting assembly is called a **gnomon**, its angled edge which casts the shadow is the **style**. The bottom of the gnomon attached to the dial plate, is the **sub-style**. An optional notch or blob is called a **nodus** indicating the calendar. Wooden gnomons warp, thick gnomons need consideration of which part of the shadow to use, holes in a gnomon can reduce wind resistance. Gnomons should not be used to catch horseshoes. The gnomon, hour lines, and the **furniture** (such as calendar lines) rest on the **dial plate**. The hour lines which indicate the time originate from the **dial center**.

The calendar, is often marked by three lines. The curves (hyperbolae) are solar declination lines and often show the solstices (December 21, June 21, approximately), and the straight line marks the equinoxes (March 21 and September 21, approximately). The 21st of March, June, September, and December are the conventional days for the solstices and equinoxes, however a few days either side are sometimes used.

Accurate dials are designed for a specific latitude, the hour lines depend on it as does the angle between the style and the sub-style (style height). Since sundials are seldom on the legal time meridian, they need longitude correction to either be built in, or require some mental arithmetic. The sun appears to be slow or fast at times, so dials need to be corrected for what is called the equation of time. These corrections can be designed into the dial, or provided as a table for the user to mentally adjust the displayed time to legal time.

CHAPTER 5

A HORIZONTAL DIAL

The horizontal dial spends its life perfectly level. The gnomon is always aligned to true north, and its style is always parallel to the earth's polar axis, so the sun revolves in a circle around that style. That means that the style forms an angle with the sub-style that is equal to the latitude.

The style is at the latitude angle, and points true north.

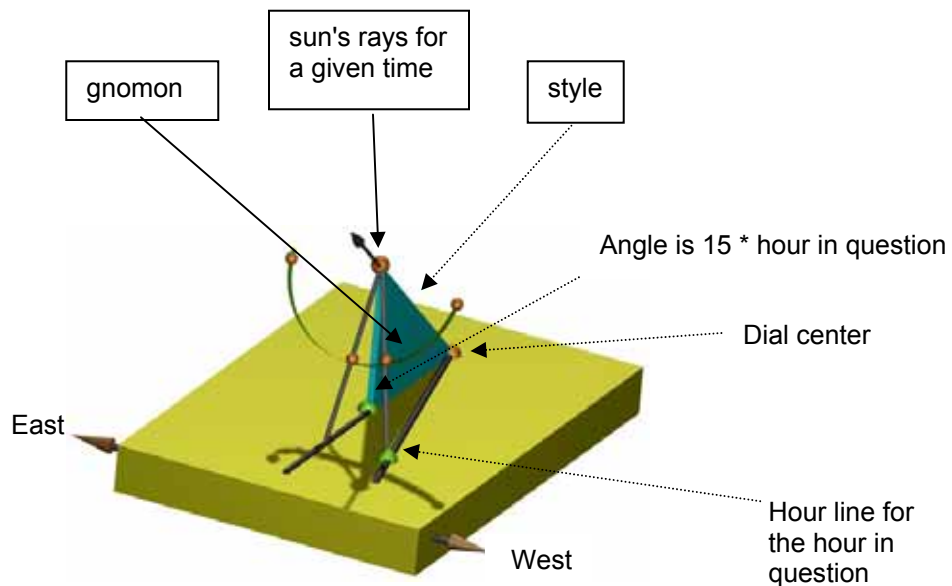

Latitude affects the style, and thus the hour lines. The noon hour line should be an extension of the sub-style if longitude correction is not built in. Longitude corrections made to cause the LAT (local apparent time) to match the legal meridian result in the noon line no longer being an extension of the sub-style line. To make the dial perfectly match legal time, we must also account for the equation of time.

THE GEOMETRICAL METHOD FOR A HORIZONTAL DIAL

Consider a dial plate ABCD. In its center draw a noon line XY. From X draw a line XZ that makes an angle with XY equal to the latitude. In essence this is the gnomon's style rotated 90 degrees and thus is lying flat on the surface of the dial plate as if the wind blew it over, resting peacefully.

Draw a line perpendicular to the style that goes to Y, that point on the style is labeled Z. Or, from Y draw a line to Z, the angle XYZ being the co-latitude, and thus intercepts the style at 90 degrees.

Our gnomon is WXZ when rotated back vertically. ZY is the path the sun's rays travel at the equinox at solar noon.

Rotate YZ to the top as YR, and then draw a semi-circular protractor LYM centered on R.

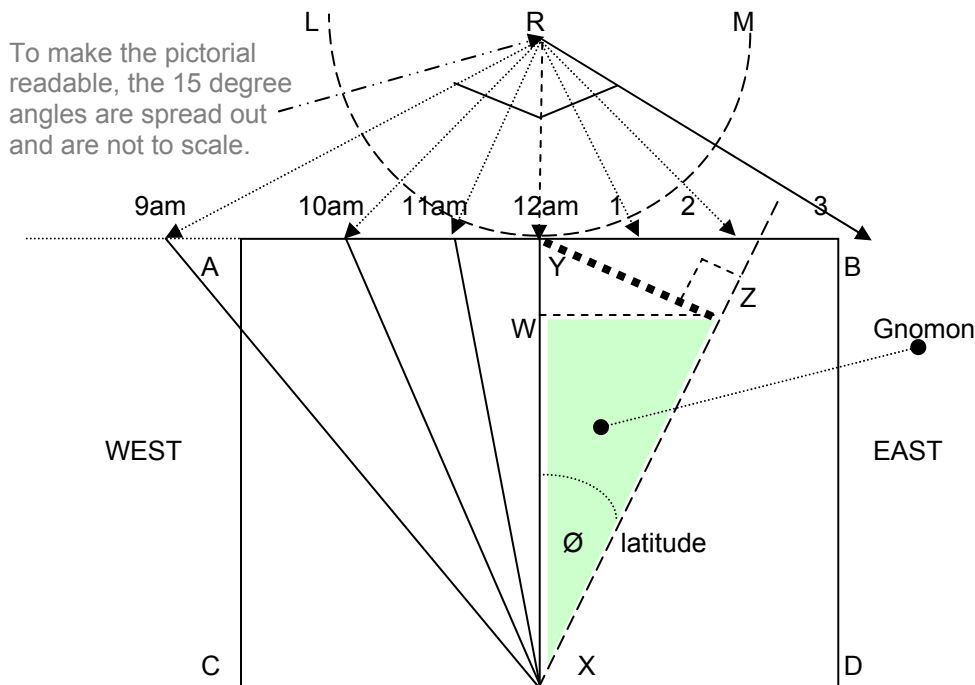

Then mark off 15 degree marks on the protractor LYM, and extend the protractor's 15 degree lines to AB. Finally, the hour lines are drawn from the dial center up to where the protractor lines meet the west to east line AB.

The equation of time, EOT, is managed mentally by a printed table for the sundial observer to consider, and the longitude correction can be folded in to that table.

A technique for hours some time off from noon

Extend the 45 degree line RB and the plate bottom line CD so they meet at J, similarly on the other side to meet at K. Or, make lines XK and XJ equal in length to XR. Drop perpendiculars from A to C and from B to D so that intersections for the early and late hours can be drawn on lines AC and BD.

At those new centers K, and J, draw a protractor and mark off the 15 degree arcs and have them intercept BD and AC.

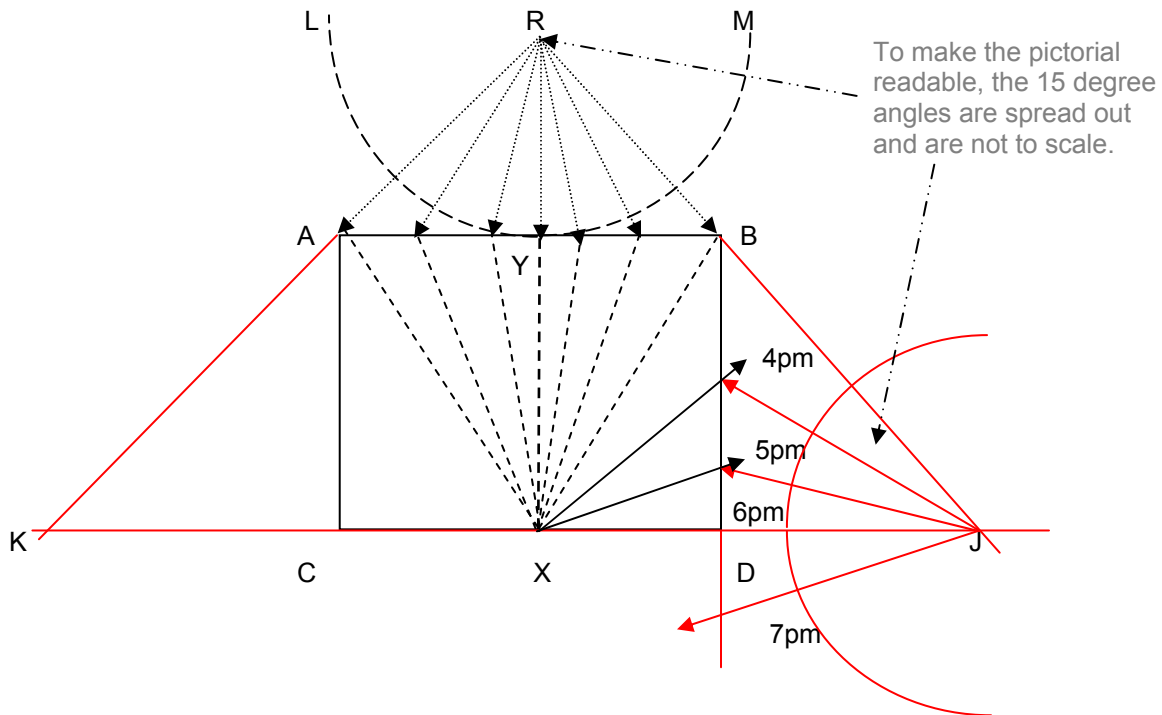

The protractor process is repeated on the left side. This provides the 4, 5, and 6pm lines, even 7pm and 8pm. Similarly the 4am, 5am, 6am, 7am, and 8am lines.

This technique has the benefit of being able to draw hour lines whose distance along "AB" would be excessive using the simple single protractor approach.

THE TRIGONOMETRIC METHOD FOR HORIZONTAL DIAL HOUR LINES

Consider CSP to be the gnomon, CS being the style, CP the sub-style. From S extend a perpendicular to a new point Q on the East-West line. As the sun moves by "ha" degrees from noon, a new hour line is drawn whose angle is H.

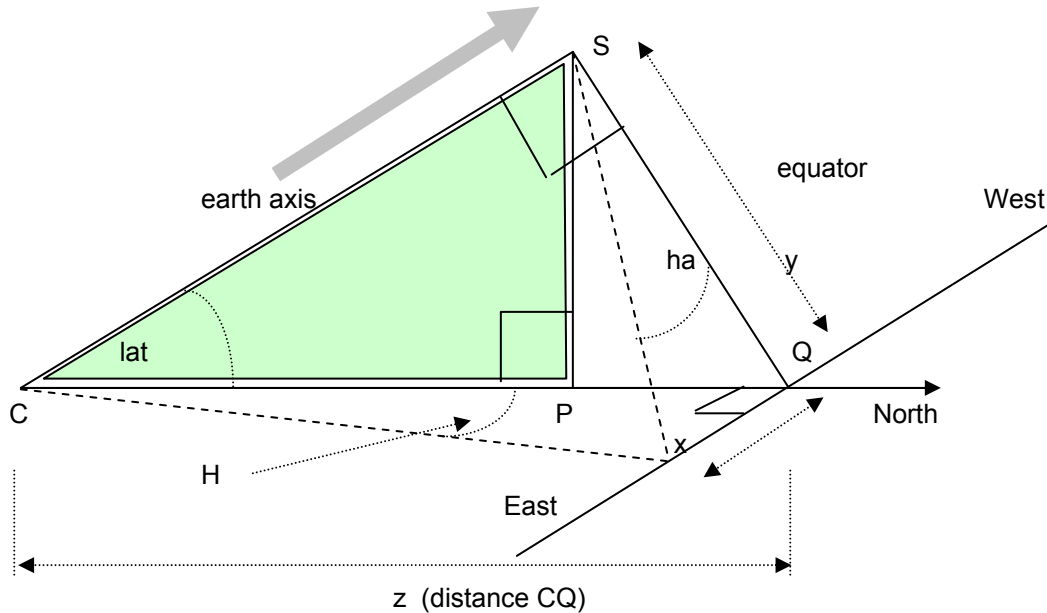

- | | | |
|-----|---|--|
| (1) | $\tan (ha) = x/y$ | \tan of hour angle (15 degrees * hour) |
| (2) | $x = y * \tan (ha)$ | thusly |
| (3) | $\tan (H) = x/z$ | \tan of the hour line angle |
| (4) | $\sin (lat) = y/z$ | \sin of latitude or \emptyset |
| (5) | $y = z * \sin (lat)$ | thusly |
| (6) | $H = \text{atan} (x/z) = \text{atan} ((y * \tan (ha)) / z)$
$= \text{atan} ((z * \sin (lat) * \tan (ha)) / z))$
$= \text{atan} (\sin (lat) * \tan (ha))$ | |

So, to calculate any hour line from the sub style: $H = \arctan (\sin (lat) * \tan (ha))$

The hours used in the hour line formula may be adjusted for longitude. If you use a spreadsheet then trigonometric functions use radians, and must be converted back using degrees. The formula is then something like:-

$$\text{DEGREES}(\text{ATAN}(\text{TAN}(\text{RADIANS}(15*\text{time})) * \text{SIN}(\text{RADIANS}(\text{latitude}))))$$

Tables can be used which are trigonometric in nature

Appendix 3 has tables with hour line angles calculated for various latitudes.



COOK BOOK SUMMARY

HORIZONTAL DIAL: Geometric

Hour lines:

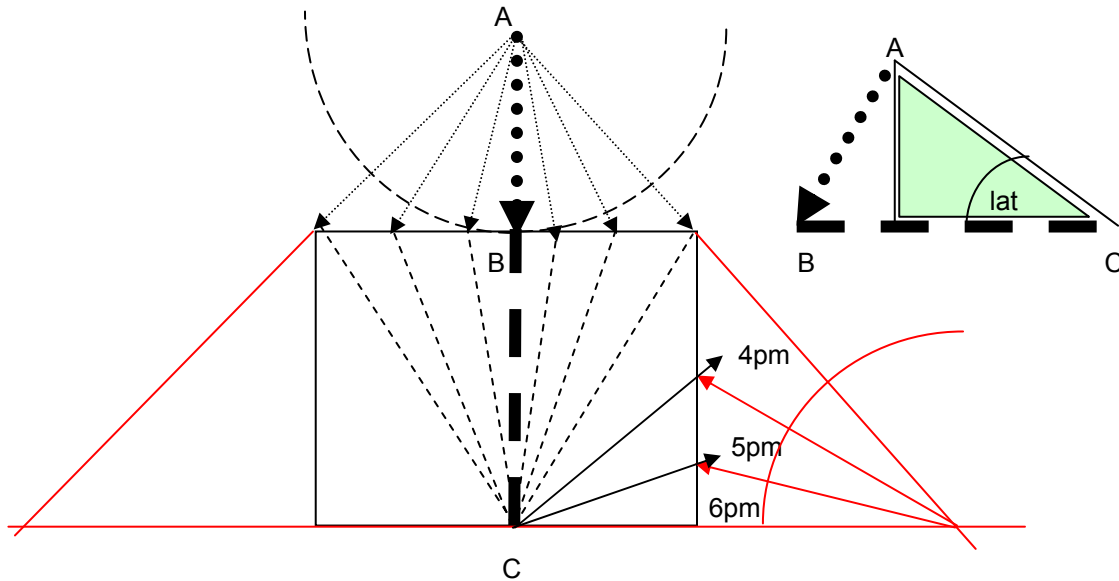

HORIZONTAL DIAL: Trigonometric

Hour lines: $\text{hour line angle} = \arctan(\sin(\text{latitude}) * \tan(15 * \text{hour}))$

HORIZONTAL DIAL: Tabular

Appendix 3 tables A3,1a, A31.b, A3.1c provide the hour lines by latitude.

note: the photo to the right of a horizontal dial has a deliberately wide gnomon to show how gnomon width is managed, the photo was taken from above the dial.

The appendices have a template for laying out a horizontal dial, and on the following page, that template is used to facilitate drawing the dial plate.

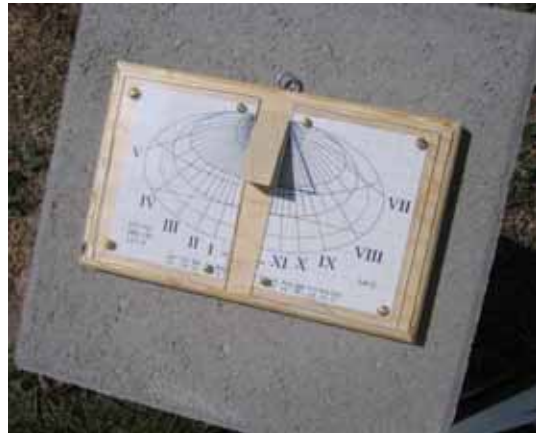

HORIZONTAL DIAL: Method: Using Tables: [appendix 9 has the template used here]

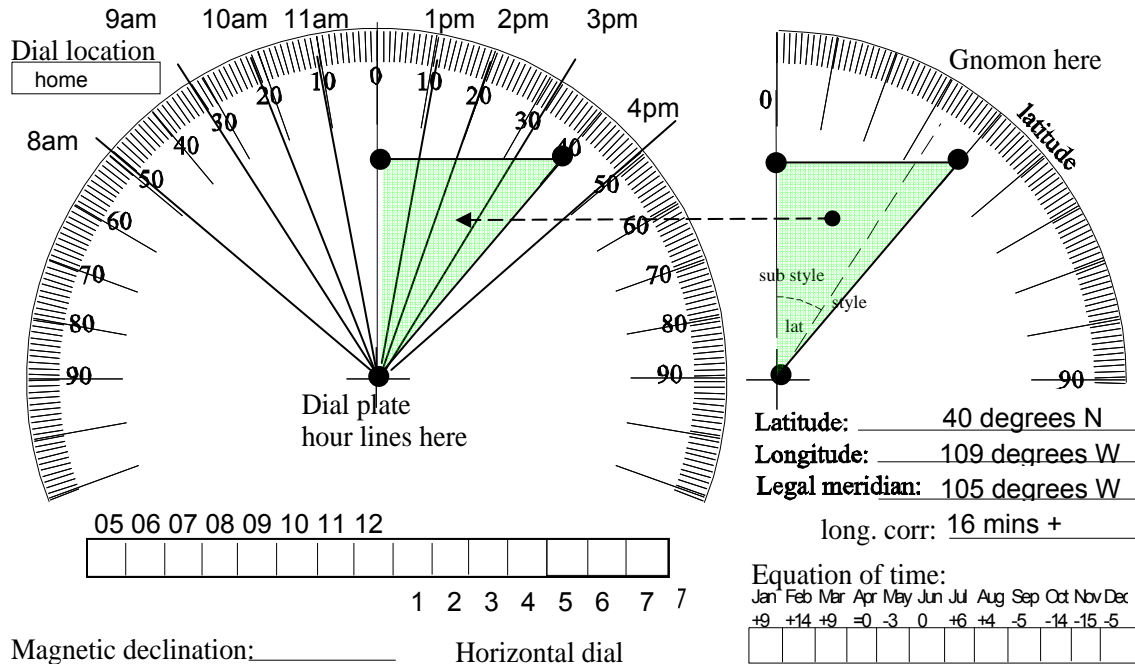

This template may be copied provided credit is given to Illustrating Shadows, www.illustratingshadows.com and Simon Wheaton-Smith

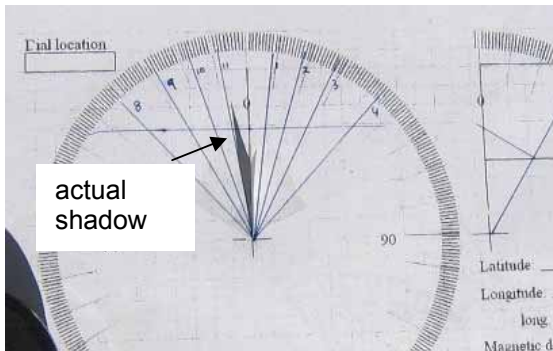

Appendix 3 table A3.1b for latitude 40 provides the following hour line angles assuming no longitude correction.

- 8am and 4pm 48.07 degrees
- 9am and 3pm 32.73 degrees
- 10am and 2pm 20.36 degrees
- 11am and 1pm 9.77 degrees etc

The hour lines before and after noon are drawn. The gnomon is drawn and moved to dial center. The longitude correction of 4 degrees (at 4

minutes per degree) is 16 minutes, and is west of longitude 105 thus we must add the time. The longitude correction of 16 minutes is added to the equation of time, producing:-

Jan	Feb	Mar	Apr	May	Jun	Jly	Aug	Sep	Oct	Nov	Dec
+25	+30	+25	+16	+13	+16	+22	+20	+11	+2	+1	+11

The dial plate is aligned to true north, and the shadow is mentally corrected with the revised equation of time (EOT). Alternatively the hour lines could be adjusted individually for longitude, however the dial would no longer be portable. If the hour lines were longitude adjusted, they would simple be rotated, but by an angle calculated for a time corrected by the 16 minutes, one hour line at a time. The equinox line is derived by extending the gnomon from the nodus to the sub-style line extended, and perpendicular to the style. Longitude corrections of 4 or more degrees cause the resulting combined EOT table to always have the same sign. That is because 4 degrees is 16 minutes, the maximum EOT deviation. This paper dial can be tested in the sun before the final dial is built as is shown in the inset.

Hour around noon

horizontal dial nomogram for hour line angles

A nomogram is an alternative to using tables, select latitude on the left, a time on the right, and read the hour line angle in the middle.

First, mark latitude on the left vertical line
 Next, mark the desired time on the right vertical line
 Then, read hour line angle on the center vertical line

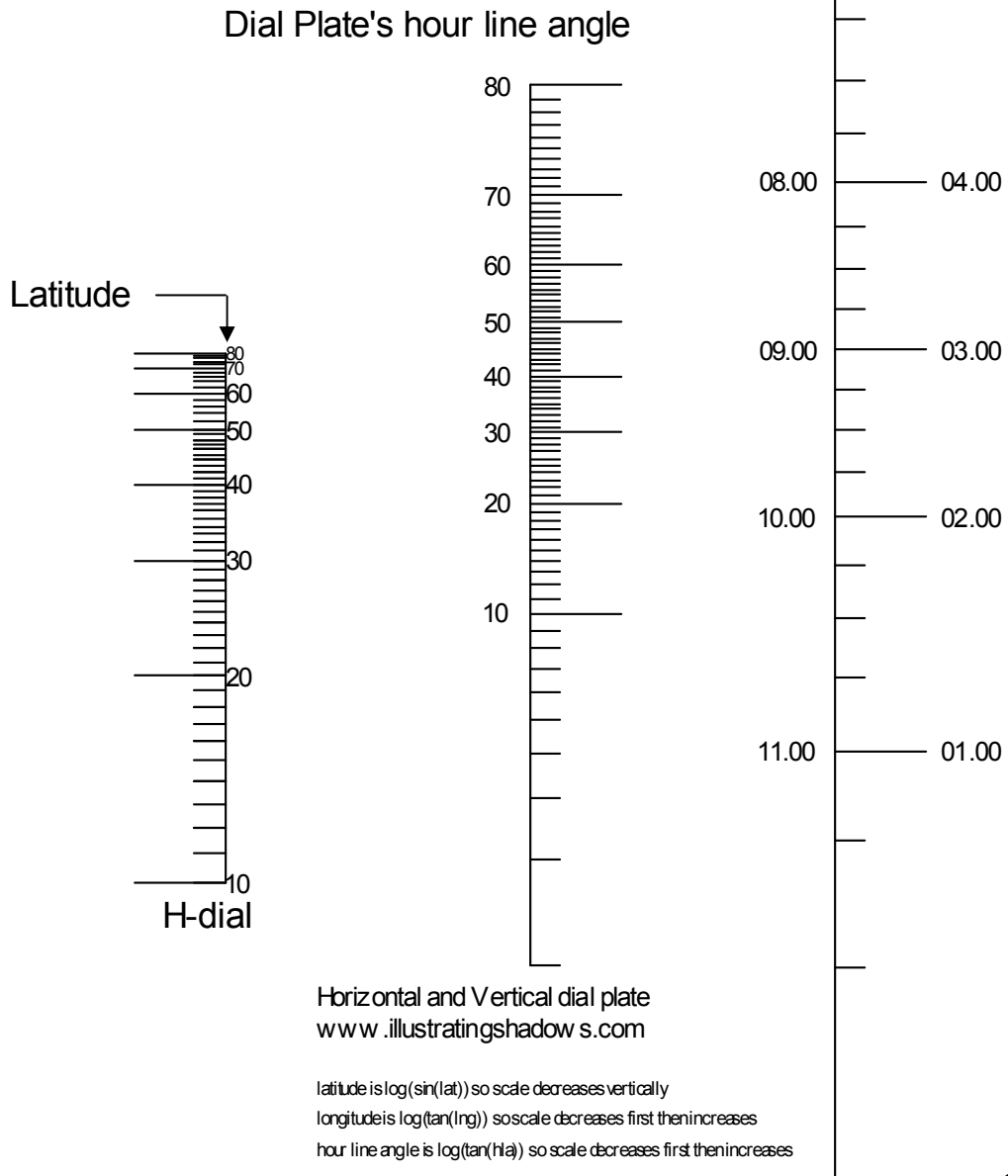

APPENDIX - 1

TRIGONOMETRY AND GEOMETRY RULES

Trigonometry has a set of functions that are defined that make working with angles and lines easy using simple mathematics. There are also certain truisms about the functions.

Pythagoras's Theorem
 $\text{sqrt}(\text{hypotenuse}) = \text{sqrt}(\text{adjacent}^2 + \text{opposite}^2)$

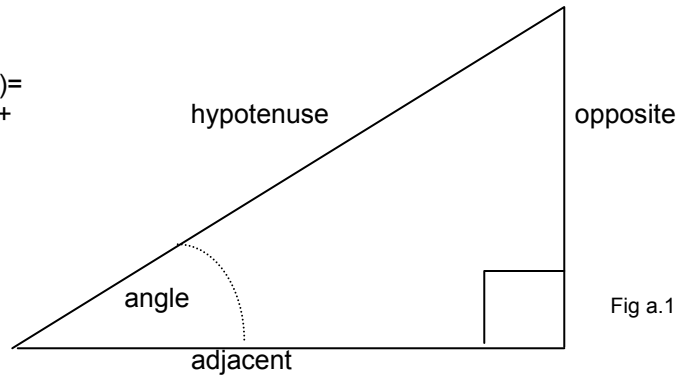

A right angles triangle has one angle that is 90 degrees, and the side opposite that angle is called the hypotenuse. For an angle other than the right angle, there are defined sides called the opposite side and the adjacent side.

And there are some predefined functions, and tables that give you their values. And spreadsheets provide this service also, however a spreadsheet usually uses "radians" rather than the more common degrees.

definitions:

$\tan(\text{angle})$	=	opposite / adjacent	[tangent]
$\sin(\text{angle})$	=	opposite / hypotenuse	[sine]
$\cos(\text{angle})$	=	adjacent / hypotenuse	[cosine]

and they are remembered with the sentence: "the old aunt, sat on her, coat and hat". The word "co" means complement of. So the cosine is the complement of the sine.

$$\cos(\text{angle}) = \sin(90 - \text{angle})$$

And for the tangent some extra things are true...

$$\begin{aligned} \cotan(\text{angle}) &= \tan(90 - \text{angle}) \\ &= 1 / \tan(\text{angle}) \end{aligned}$$

is easily proved because 90-angle is the opposite angle and thus its tan is the old adjacent divided by the old opposite.

Also you can deduce: $\tan(\text{angle}) = \sin(\text{angle}) / \cos(\text{angle})$

The angle whose sine is x is referred to as $\arcsin(x)$, similarly for arcos and arctan, or asin, acos, and atan. Sometimes the symbol $\sin^{-1}(\text{value})$, \cos^{-1} , and \tan^{-1} are used.

Geometry is the drawing of lines, arcs, circles and the like. It relates to trigonometry, however it can be used independently.

Geometry can also use techniques such as rotating something on its side, such as a protractor on a gnomon, whereas doing that rotation in trigonometry would be much harder since it would involve three dimensions.

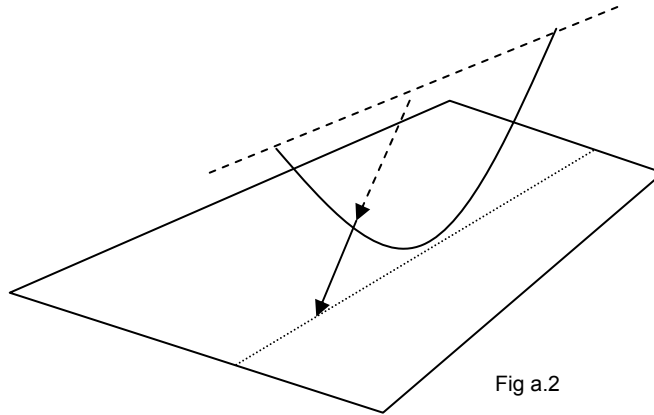

Fig a.2

For example, above we see a protractor perpendicular to a plane and it has some angle marked. With geometry we can fold the protractor down to be in line with the plane which makes things much easier.

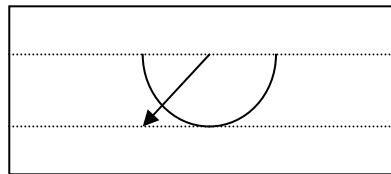
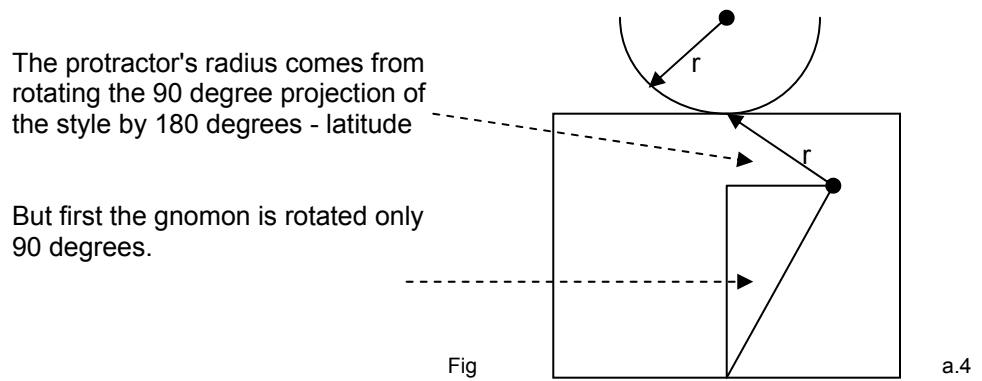

Fig a.3

And these projections are very helpful in working out sundial problems. Where geometric methods were used, they were nothing more than rotations of planes by sometimes 90 degrees, sometimes by less.

CAUTION: Some projections are not just 90 degree rotations. For example, in the horizontal dial, the gnomon is rotated 90 degrees first, and then a 90 degree line drawn from the nodus to the plate, and that is then rotated more than 90 degrees in effect, because the protractor's radius is the 90 degree line from the nodus and not the vertical dropped from the nodus to the dial plate.



TRIANGLES AND THINGS

All normal (i.e. non spherical) triangles have angles that add up to 360 degrees, a right angled triangle has one angle of 90 degrees, and an isosoles triangles has two of the angles equal and thus less than 90 degrees, and an equilateral triangle has all three angles equal and they are 60 degrees each.

CIRCLES AND THINGS

A circle has a center, and the perimeter of the circle is a constant distance from the center, that distance is called the radius.

The diameter is the distance between two points on the perimeter , or circumference, passing through the center, and is twice the length of the radius.

The length of the perimeter, it's circumference, is:-

$$\begin{aligned} \text{circumference} &= 2 * 3.1416 * \text{radius} \\ \text{circumference} &= 3.1416 * \text{diameter} \end{aligned}$$

The number 3.1416 is called pi, symbol π , and occurs in many circular mathematical expressions.

The circumference is divided up into degrees, degrees of arc, and there are 360 degrees in a circle, or 180 degrees in a semi-circle. Other measures are used, the next most common, especially when using spreadsheets, is the radian. There are $2 * \pi$, i.e. $2 * 3.1416$, or 6.2832 radians in a circle, so one radian is 57.296 degrees.

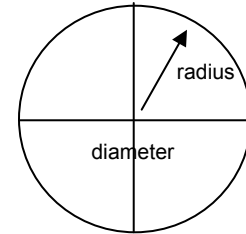

circumference is the length of the perimeter.

The radius, diameter, and circumference formulae are helpful in armillary and equatorial dials.

"A 4.5 inch pipe cap-end was cut and used, the radius was thus 2.25 inches, being thusly the gnomon to dial plate distance. The hour lines are a simple 15 degrees, or $3.1416 * \text{diameter} / 24$, i.e. $3.1416 * 4.5 / 24 = 0.58905$ inches apart. Useful when using CAD to draw a template."

TRIGONOMETRIC FUNCTIONS

A1.1

degrees	radians	sin	cos	tan	cotan	degrees	radians	sin	cos	tan	cotan
1	0.017	0.0175	0.9998	0.0175	57.2900	46	0.803	0.7193	0.6947	1.0355	0.9657
2	0.035	0.0349	0.9994	0.0349	28.6363	47	0.820	0.7314	0.6820	1.0724	0.9325
3	0.052	0.0523	0.9986	0.0524	19.0811	48	0.838	0.7431	0.6691	1.1106	0.9004
4	0.070	0.0698	0.9976	0.0699	14.3007	49	0.855	0.7547	0.6561	1.1504	0.8693
5	0.087	0.0872	0.9962	0.0875	11.4301	50	0.873	0.7660	0.6428	1.1918	0.8391
6	0.105	0.1045	0.9945	0.1051	9.5144	51	0.890	0.7771	0.6293	1.2349	0.8098
7	0.122	0.1219	0.9925	0.1228	8.1443	52	0.908	0.7880	0.6157	1.2799	0.7813
8	0.140	0.1392	0.9903	0.1405	7.1154	53	0.925	0.7986	0.6018	1.3270	0.7536
9	0.157	0.1564	0.9877	0.1584	6.3138	54	0.942	0.8090	0.5878	1.3764	0.7265
10	0.175	0.1736	0.9848	0.1763	5.6713	55	0.960	0.8192	0.5736	1.4281	0.7002
11	0.192	0.1908	0.9816	0.1944	5.1446	56	0.977	0.8290	0.5592	1.4826	0.6745
12	0.209	0.2079	0.9781	0.2126	4.7046	57	0.995	0.8387	0.5446	1.5399	0.6494
13	0.227	0.2250	0.9744	0.2309	4.3315	58	1.012	0.8480	0.5299	1.6003	0.6249
14	0.244	0.2419	0.9703	0.2493	4.0108	59	1.030	0.8572	0.5150	1.6643	0.6009
15	0.262	0.2588	0.9659	0.2679	3.7321	60	1.047	0.8660	0.5000	1.7321	0.5774
16	0.279	0.2756	0.9613	0.2867	3.4874	61	1.065	0.8746	0.4848	1.8040	0.5543
17	0.297	0.2924	0.9563	0.3057	3.2709	62	1.082	0.8829	0.4695	1.8807	0.5317
18	0.314	0.3090	0.9511	0.3249	3.0777	63	1.100	0.8910	0.4540	1.9626	0.5095
19	0.332	0.3256	0.9455	0.3443	2.9042	64	1.117	0.8988	0.4384	2.0503	0.4877
20	0.349	0.3420	0.9397	0.3640	2.7475	65	1.134	0.9063	0.4226	2.1445	0.4663
21	0.367	0.3584	0.9336	0.3839	2.6051	66	1.152	0.9135	0.4067	2.2460	0.4452
22	0.384	0.3746	0.9272	0.4040	2.4751	67	1.169	0.9205	0.3907	2.3559	0.4245
23	0.401	0.3907	0.9205	0.4245	2.3559	68	1.187	0.9272	0.3746	2.4751	0.4040
24	0.419	0.4067	0.9135	0.4452	2.2460	69	1.204	0.9336	0.3584	2.6051	0.3839
25	0.436	0.4226	0.9063	0.4663	2.1445	70	1.222	0.9397	0.3420	2.7475	0.3640
26	0.454	0.4384	0.8988	0.4877	2.0503	71	1.239	0.9455	0.3256	2.9042	0.3443
27	0.471	0.4540	0.8910	0.5095	1.9626	72	1.257	0.9511	0.3090	3.0777	0.3249
28	0.489	0.4695	0.8829	0.5317	1.8807	73	1.274	0.9563	0.2924	3.2709	0.3057
29	0.506	0.4848	0.8746	0.5543	1.8040	74	1.292	0.9613	0.2756	3.4874	0.2867
30	0.524	0.5000	0.8660	0.5774	1.7321	75	1.309	0.9659	0.2588	3.7321	0.2679
31	0.541	0.5150	0.8572	0.6009	1.6643	76	1.326	0.9703	0.2419	4.0108	0.2493
32	0.559	0.5299	0.8480	0.6249	1.6003	77	1.344	0.9744	0.2250	4.3315	0.2309
33	0.576	0.5446	0.8387	0.6494	1.5399	78	1.361	0.9781	0.2079	4.7046	0.2126
34	0.593	0.5592	0.8290	0.6745	1.4826	79	1.379	0.9816	0.1908	5.1446	0.1944
35	0.611	0.5736	0.8192	0.7002	1.4281	80	1.396	0.9848	0.1736	5.6713	0.1763
36	0.628	0.5878	0.8090	0.7265	1.3764	81	1.414	0.9877	0.1564	6.3138	0.1584
37	0.646	0.6018	0.7986	0.7536	1.3270	82	1.431	0.9903	0.1392	7.1154	0.1405
38	0.663	0.6157	0.7880	0.7813	1.2799	83	1.449	0.9925	0.1219	8.1443	0.1228
39	0.681	0.6293	0.7771	0.8098	1.2349	84	1.466	0.9945	0.1045	9.5144	0.1051
40	0.698	0.6428	0.7660	0.8391	1.1918	85	1.484	0.9962	0.0872	11.4301	0.0875
41	0.716	0.6561	0.7547	0.8693	1.1504	86	1.501	0.9976	0.0698	14.301	0.0699
42	0.733	0.6691	0.7431	0.9004	1.1106	87	1.518	0.9986	0.0523	19.081	0.0524
43	0.750	0.6820	0.7314	0.9325	1.0724	88	1.536	0.9994	0.0349	28.636	0.0349
44	0.768	0.6947	0.7193	0.9657	1.0355	89	1.553	0.9998	0.0175	57.290	0.0175
45	0.785	0.7071	0.7071	1.0000	1.0000	90	1.571	1.0000	0.0000	inf	0.0000

APPENDIX 2 - Tables independent of location

EQUATION OF TIME ~ EOT

EQUATION OF TIME TABLE								minutes:seconds mm.ss				
	Jan	Feb	Mar	Apr	May	Jun	Jul	Aug	Sep	Oct	Nov	Dec
1	3:09	13:34	12:17	3:49	-2:54	-2:09	3:51	6:17	0:02	-10:21	-16:21	-10:52
2	4:07	13:42	12:05	3:32	-3:01	-1:59	4:03	6:13	-0:22	-10:40	-16:22	-10:29
3	4:34	13:48	11:52	3:14	-3:07	-1:50	4:14	6:08	-0:41	-10:59	-16:22	-10:06
4	5:02	13:54	11:39	2:57	-3:13	-1:39	4:25	6:03	-1:01	-11:17	-16:22	-9:42
5	5:28	13:59	11:26	2:39	-3:18	-1:29	4:35	5:57	-1:21	-11:35	-16:20	-9:17
6	5:55	14:03	11:12	2:22	-3:23	-1:18	4:45	5:51	-1:41	-11:53	-16:18	-8:52
7	6:21	14:06	10:58	2:06	-3:27	-1:07	4:55	5:43	-2:01	-12:10	-16:15	-8:27
8	6:46	14:09	10:43	1:49	-3:30	-0:56	5:04	5:36	-2:22	-12:27	-16:11	-8:00
9	7:11	14:10	10:28	1:33	-3:33	-0:44	5:13	5:27	-2:43	-12:43	-16:06	-7:34
10	7:35	14:11	10:13	1:16	-3:35	-0:32	5:22	5:19	-3:03	-12:59	-16:00	-7:07
11	7:59	14:12	9:57	1:01	-3:37	-0:20	5:30	5:09	-3:24	-13:15	-15:54	-6:39
12	8:22	14:11	9:42	0:45	-3:38	-0:08	5:37	4:59	-3:46	-13:30	-15:46	-6:11
13	8:44	14:10	9:25	0:30	-3:39	0:04	5:44	4:48	-4:07	-13:44	-15:38	-5:43
14	9:06	14:08	9:09	0:15	-3:39	0:16	5:51	4:37	-4:28	-13:58	-15:29	-5:15
15	9:27	14:05	8:52	0:00	-3:38	0:29	5:57	4:26	-4:49	-14:12	-15:19	-4:46
16	9:48	14:01	8:35	-0:13	-3:37	0:42	6:03	4:13	-5:11	-14:25	-15:09	-4:17
17	10:08	13:57	8:18	-0:27	-3:36	0:55	6:08	4:01	-5:32	-14:37	-14:57	-3:48
18	10:27	13:52	8:01	-0:40	-3:34	1:08	6:13	3:48	-5:53	-14:49	-14:45	-3:19
19	10:45	13:47	7:43	-0:53	-3:31	1:21	6:17	3:34	-6:15	-15:00	-14:31	-2:49
20	11:03	13:40	7:25	-1:06	-3:27	1:34	6:20	3:20	-6:36	-15:10	-14:17	-2:19
21	11:20	13:33	7:08	-1:18	-3:24	1:47	6:23	3:05	-6:57	-15:20	-14:02	-1:50
22	11:36	13:26	6:50	-1:30	-3:19	2:00	6:26	2:50	-7:18	-15:29	-13:47	-1:20
23	11:52	13:18	6:32	-1:41	-3:14	2:13	6:28	2:34	-7:39	-15:38	-13:30	-0:50
24	12:06	13:09	6:14	-1:52	-3:09	2:26	6:29	2:18	-8:00	-15:46	-13:13	-0:20
25	12:20	13:00	5:56	-2:03	-3:03	2:39	6:30	2:02	-8:21	-15:53	-12:55	0:08
26	12:33	12:50	5:37	-2:12	-2:57	2:51	6:30	1:45	-8:41	-15:59	-12:36	0:38
27	12:45	12:39	5:19	-2:22	-2:50	3:04	6:29	1:28	-9:02	-16:05	-12:17	1:07
28	12:57	12:28	5:01	-2:31	-2:43	3:16	6:28	1:10	-9:22	-16:09	-11:57	1:37
29	13:07		4:43	-2:39	-2:35	3:28	6:26	0:52	-9:42	-16:14	-11:36	2:06
30	13:17		4:25	-2:47	-2:27	3:40	6:24	0:34	-10:01	-16:17	-11:14	2:35
31	12:26		4:07		-2:18		6:21	0:16		-16:19		3:03

If "+" then add to solar time to get mean time as the sun is slow. If "-" then subtract from solar time to get mean time as the sun is fast. Some tables have a plus for our minus and vice versa. If in doubt look at the figure of eight equation of time. **Formulae involving dates** use approximations thus these tables may disagree with other sources using other formulae. This and other publications have figures that are well within drafting tolerances.

EOT (decimal mm.ss) SIMPLIFIED

GENERIC EOT TABLE			
	5th	15th	25th
JAN	5.1	9.0	12.0
FEB	13.9	14.2	13.4
MAR	11.9	9.3	6.3
APR	2.8	0.0	-2.3
MAY	-3.6	-4.0	-3.5
JUN	-2.0	-0.1	2.0
JLY	3.9	5.3	5.9
AUG	5.4	3.8	1.4
SEP	-2.2	-5.8	-9.4
OCT	-12.7	-15.1	-16.5
NOV	-16.5	-15.1	-12.5
DEC	-8.8	-4.5	0.2

Rather than make hour lines and their angles conform to the dial's location, it may be wiser to have an equation of time incorporating the longitude difference. This facilitates dial portability. Since time zones tend to be 7.5 degrees wide, a table is provided to cover that longitude span.

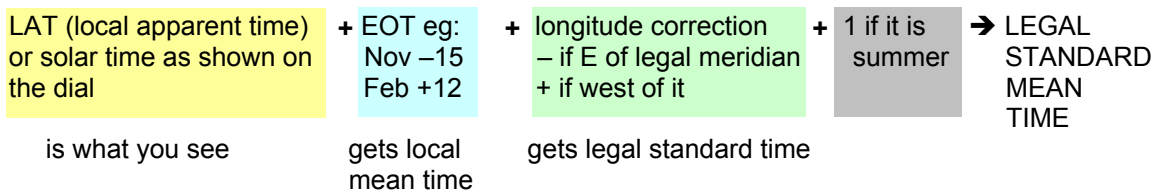

Tables A2.1b and A2.1c use a two sine wave formula which differs from table A2.1 which is why their figures differ.

When using any EOT values, always know what they indicate, their sign, and what assumptions have been made.

A2.5

CITY DATA WITH LATITUDE, LONGITUDE AND ITS CORRECTION

City id	Country, State, City			Hemi-sphere	Lat	Long	Mag var	Time ref	Long corr
					+n -s	+w -e			
	UK		London	N +ve	51.5	0.5	2.5w	0	2
	UK		Weymouth	N +ve	50.6	2.5	3.4w	0	10
PHX	USA	AZ	Phoenix	N +ve	33.5	112.0	11.8e	105	28
SDL	USA	AZ	Scottsdale	N +ve	33.6	111.9	11.8e	105	27.6
LAX	USA	CA	Los Angeles	N +ve	34.0	118.3	13.4e	120	-6.8
SAN	USA	CA	San Diego	N +ve	32.8	117.2	13.1e	120	-11.2
SFO	USA	CA	San Fransisco	N +ve	37.8	122.5	15.4e	120	10
DEN	USA	CO	Denver	N +ve	39.8	105.0	10.2e	105	0
DCA	USA	DC	Washington	N +ve	38.9	77.0	10.3w	75	8
CHI	USA	IL	Chicago,	N +ve	41.8	87.8	2.2w	90	-8.8
SVC	USA	NM	Silver City	N +ve	32.8	108.2	10.6e	105	12.8
LAS	USA	NV	Las Vegas	N +ve	36.2	115.2	13.3e	120	-19.2
JFK	USA	NY	New York	N +ve	40.7	73.8	13.8w	75	-4.8
OKC	USA	OK	Oklahoma City	N +ve	35.3	97.5	5.4e	90	30
ELP	USA	TX	El Paso	N +ve	31.8	106.5	10.1e	105	6

DAYLIGHT SAVING TIME AND TABLE OF TIME ZONES

A2.6

Zone	Name	Meridian	GMT+
	Newfoundland	52.5	3.5
4	Atlantic	60	4
5	Eastern	75	5
6	Central	90	6
7	Mountain	105	7
8	Pacific	120	8
9	Yukon	135	9
10	Alaska-Hawaii	150	10
11	Bering	165	11
	GMT Greenwich Mean Time		0
	BST British Summer Time		-1
	IST Irish Summer Time		-1
	WET Western Europe Time		0
	WEST Western Europe Summer Time		-1
	CET Central Europe Time		-1
	CEST Central Europe Summer Time		-2
	EET Eastern Europe Time		-2
	EEST Eastern Europe Summer Time		-3
	MSK Moscow Time		-3
	MSD Moscow Summer Time		-4

SUMMER TIME RULES

USA: first Sunday of April to the last Sunday of October. (some exceptions e.g. AZ, HI, etc)

EU: last Sunday in March to the last Sunday in October.

The website: <http://webexhibits.org/daylightsaving/> has other useful information.

MAGNETIC DECLINATION & VARIATION

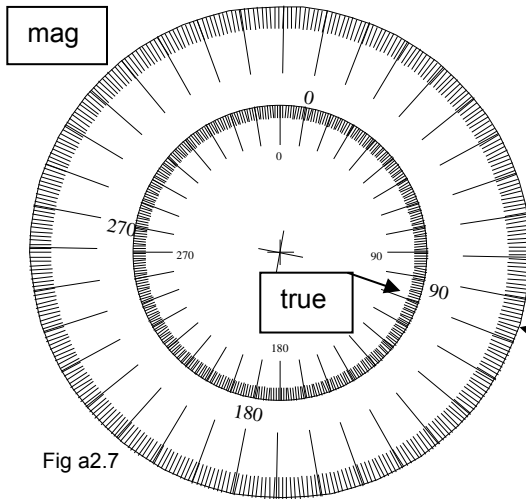

Magnetic variation is 11 degrees East

For the visually inclined, or for those who get confused at times with adding and subtracting magnetic variation (pilots and seamen call it variation) or magnetic declination (solar enthusiasts call it this), here are some diagrams aimed at simplifying the task.

Identify the magnetic bearing, for example 096 measured on a compass where the variation is 11 degrees east.

096 degrees on the outer scale is
 108 degrees on the inner scale

If the variation is easterly, ADD the variation to the magnetic bearing, and if the results is more than 360 degrees, subtract 360.

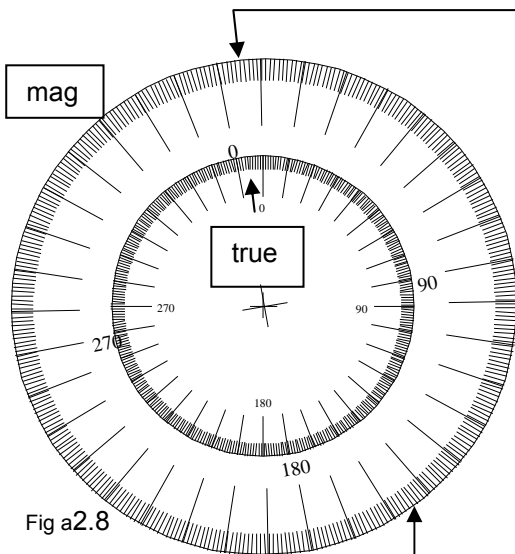

Magnetic variation is 11 degrees West

Identify the magnetic bearing, for example 005 measured on a compass where the variation is 11 degrees west.

005 degrees on the outer scale is
 354 degrees on the inner scale

If the variation is westerly, SUBTRACT the variation from the magnetic bearing, and if the results is more than 360 degrees, subtract 360.

You may consider drawing some protractors or rulers for your location, you may copy the two rulers below, cut them and slide them to show the magnetic declination.

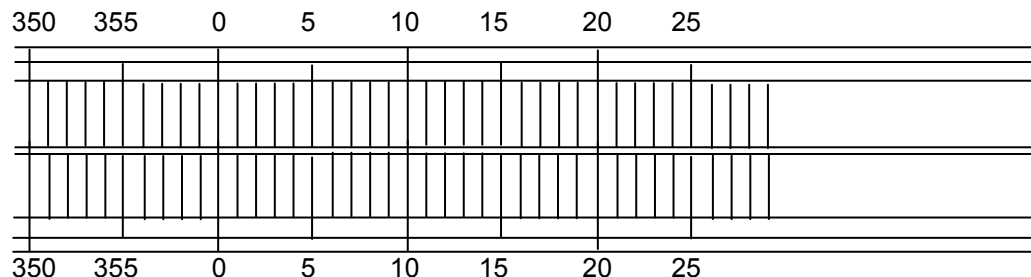

APPENDIX 3

TABLES THAT CONSIDER LOCATION

HORIZONTAL (AND VERTICAL DIAL) HOUR LINE ANGLES

HOUR LINE ANGLES Horizontal dial

hour angle DEGREES(ATAN(TAN(RADIANS(15*time))*SIN(RADIANS(lat))))

hour angle H = atan (sin(lat) * tan (ha))

TIME	HORIZONTAL DIAL LATITUDE										
	30	31	32	33	34	35	36	37	38	39	
12	0.00	0.00	0.00	0.00	0.00	0.00	0.00	0.00	0.00	0.00	noon
0.25	1.88	1.93	1.99	2.04	2.10	2.15	2.21	2.26	2.31	2.36	11.75
0.50	3.77	3.88	3.99	4.10	4.21	4.32	4.42	4.53	4.63	4.74	11.50
0.75	5.68	5.85	6.02	6.18	6.35	6.51	6.67	6.83	6.98	7.14	11.25
1	7.63	7.86	8.08	8.30	8.52	8.74	8.95	9.16	9.37	9.57	11
1.25	9.63	9.92	10.20	10.47	10.75	11.02	11.28	11.55	11.80	12.06	10.75
1.50	11.70	12.04	12.38	12.71	13.04	13.36	13.68	14.00	14.31	14.61	10.50
1.75	13.85	14.25	14.65	15.03	15.42	15.79	16.16	16.53	16.89	17.24	10.25
2	16.10	16.56	17.01	17.46	17.89	18.32	18.75	19.16	19.57	19.97	10
2.25	18.47	18.99	19.50	20.00	20.49	20.97	21.44	21.91	22.36	22.81	9.75
2.50	20.99	21.56	22.13	22.68	23.22	23.76	24.28	24.79	25.29	25.78	9.50
2.75	23.68	24.31	24.93	25.53	26.12	26.70	27.27	27.82	28.37	28.89	9.25
3	26.57	27.25	27.92	28.57	29.21	29.84	30.45	31.04	31.62	32.18	9
3.25	29.69	30.43	31.14	31.84	32.52	33.19	33.83	34.46	35.07	35.66	8.75
3.50	33.09	33.87	34.63	35.37	36.08	36.78	37.45	38.11	38.74	39.36	8.50
3.75	36.81	37.63	38.42	39.18	39.93	40.64	41.34	42.01	42.66	43.28	8.25
4	40.89	41.74	42.55	43.33	44.08	44.81	45.51	46.19	46.84	47.47	8
4.25	45.40	46.24	47.06	47.84	48.59	49.31	50.00	50.67	51.31	51.92	7.75
4.50	50.36	51.19	51.99	52.75	53.47	54.16	54.83	55.46	56.07	56.65	7.50
4.75	55.83	56.61	57.36	58.07	58.74	59.38	59.99	60.57	61.13	61.66	7.25
5	61.81	62.51	63.18	63.80	64.40	64.96	65.49	66.00	66.48	66.94	7
5.25	68.31	68.88	69.43	69.94	70.42	70.87	71.30	71.71	72.10	72.46	6.75
5.50	75.25	75.66	76.05	76.41	76.75	77.07	77.38	77.66	77.93	78.18	6.50
5.75	82.53	82.75	82.95	83.14	83.31	83.48	83.64	83.78	83.92	84.05	6.25
6	90.00	90.00	90.00	90.00	90.00	90.00	90.00	90.00	90.00	90.00	6

NOTE: Values are degrees and tenths and hundredths of a degree. Thus latitude 39 at 1pm or 11am shows 9.57 degrees, not 9 degrees, 57 minutes. And 9.57 degrees converts to 9 degrees 34.2 minutes of arc, which is consistent with other publications.

HOUR LINE ANGLES **Horizontal dial**

hour angle DEGREES(ATAN(TAN(RADIANS(15*time))*SIN(RADIANS(lat))))
 hour angle H = atan (sin(lat) * tan (ha))

TIME	HORIZONTAL DIAL LATITUDE											
	40	41	42	43	44	45	46	47	48	49		
12	0.00	0.00	0.00	0.00	0.00	0.00	0.00	0.00	0.00	0.00	0.00	noon
0.25	2.41	2.46	2.51	2.56	2.61	2.65	2.70	2.74	2.79	2.83		11.75
0.50	4.84	4.94	5.03	5.13	5.23	5.32	5.41	5.50	5.59	5.67		11.50
0.75	7.29	7.43	7.58	7.73	7.87	8.01	8.14	8.28	8.41	8.54		11.25
1	9.77	9.97	10.16	10.36	10.54	10.73	10.91	11.09	11.26	11.43		11
1.25	12.31	12.56	12.80	13.03	13.27	13.50	13.72	13.94	14.16	14.37		10.75
1.50	14.91	15.20	15.49	15.77	16.05	16.32	16.59	16.85	17.11	17.36		10.50
1.75	17.59	17.93	18.26	18.59	18.91	19.22	19.53	19.83	20.13	20.41		10.25
2	20.36	20.75	21.12	21.49	21.85	22.21	22.55	22.89	23.22	23.54		10
2.25	23.24	23.67	24.09	24.50	24.90	25.29	25.67	26.04	26.41	26.76		9.75
2.50	26.25	26.72	27.18	27.62	28.06	28.48	28.90	29.30	29.69	30.08		9.50
2.75	29.41	29.91	30.40	30.88	31.35	31.80	32.25	32.68	33.09	33.50		9.25
3	32.73	33.27	33.79	34.29	34.79	35.26	35.73	36.18	36.62	37.04		9
3.25	36.24	36.80	37.34	37.87	38.38	38.88	39.36	39.83	40.28	40.71		8.75
3.50	39.95	40.53	41.09	41.63	42.15	42.66	43.15	43.62	44.08	44.53		8.50
3.75	43.89	44.48	45.04	45.59	46.11	46.62	47.11	47.58	48.04	48.48		8.25
4	48.07	48.65	49.21	49.75	50.27	50.77	51.25	51.71	52.16	52.58		8
4.25	52.50	53.07	53.61	54.13	54.63	55.11	55.57	56.01	56.43	56.84		7.75
4.50	57.20	57.73	58.24	58.73	59.19	59.64	60.07	60.47	60.87	61.24		7.50
4.75	62.16	62.64	63.10	63.54	63.96	64.36	64.74	65.10	65.45	65.78		7.25
5	67.37	67.78	68.18	68.55	68.91	69.25	69.57	69.88	70.17	70.45		7
5.25	72.81	73.13	73.44	73.74	74.02	74.29	74.54	74.78	75.02	75.23		6.75
5.50	78.43	78.65	78.87	79.07	79.27	79.45	79.63	79.80	79.95	80.10		6.50
5.75	84.18	84.29	84.41	84.51	84.61	84.70	84.79	84.88	84.96	85.04		6.25
6	90.00	90.00	90.00	90.00	90.00	90.00	90.00	90.00	90.00	90.00		6

APPENDIX 6 - SUNRISES AND SUNSETS

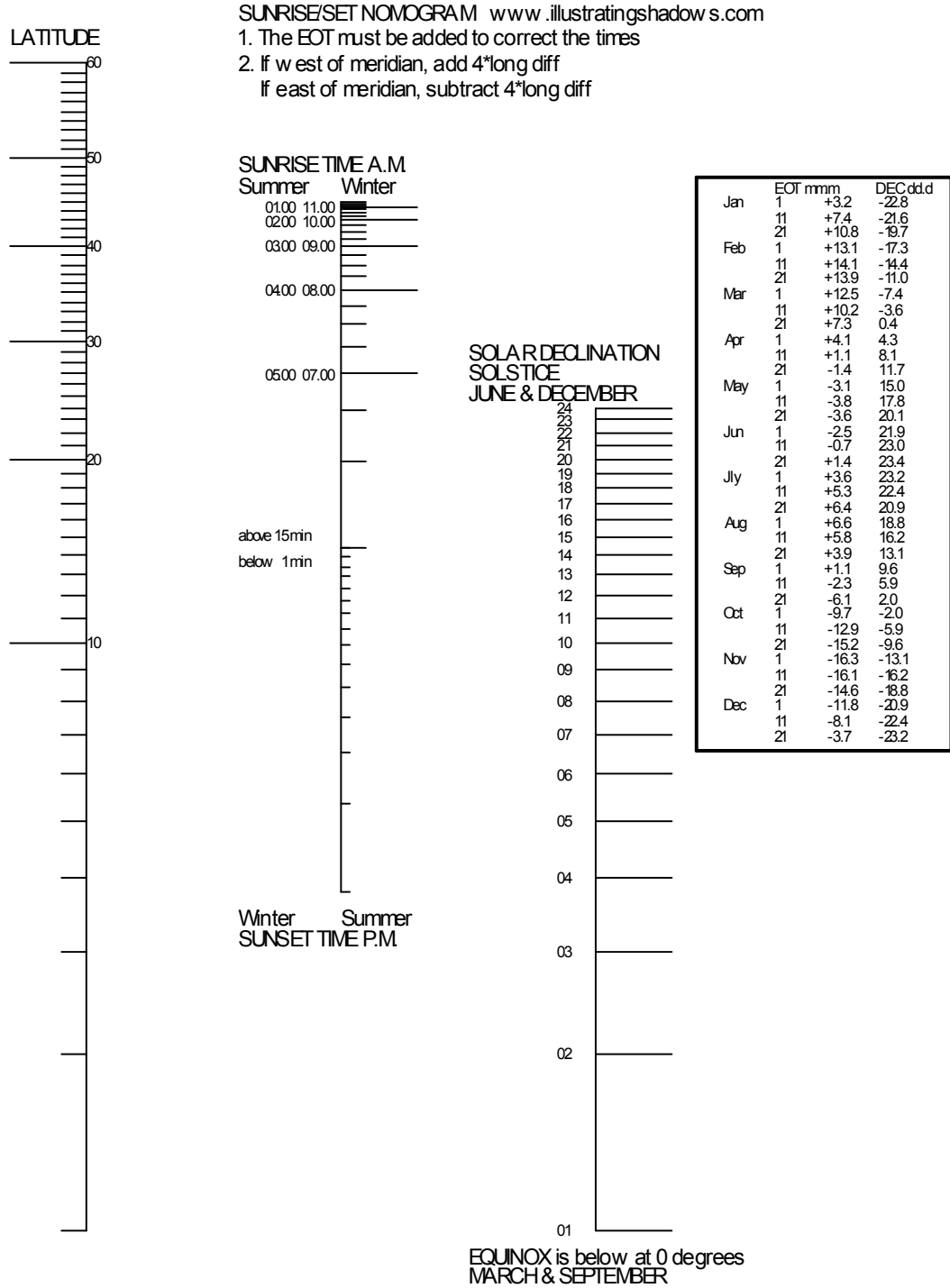

**LOCAL APPARENT TIME OF SUNRISE AND SUNSET
 for the solstices. It is 6am and 6pm for the equinoxes.**

Local apparent solar time of sunrise and sunset. Times are hh.mm
 Solstice Sunrise and Sunset (equinox is 6am/pm). No longitude correction. No EOT correction.

Winter solstice: Declination: -23.5				Summer solstice: Declination: +23.5			
Lat	Rise	Set	Day hrs	Lat	Rise	Set	Day hrs
30	6.58	17.02	10.04	30	5.01	18.59	13.58
31	7.00	17.00	10.00	31	4.59	19.01	14.02
32	7.03	16.57	9.54	32	4.56	19.04	14.08
33	7.05	16.55	9.50	33	4.54	19.06	14.12
34	7.08	16.52	9.44	34	4.51	19.09	14.18
35	7.10	16.50	9.40	35	4.49	19.11	14.22
36	7.13	16.47	9.34	36	4.46	19.14	14.28
37	7.16	16.44	9.28	37	4.43	19.17	14.34
38	7.19	16.41	9.22	38	4.40	19.20	14.40
39	7.22	16.38	9.16	39	4.37	19.23	14.46
40	7.25	16.35	9.10	40	4.34	19.26	14.52
41	7.28	16.32	9.04	41	4.31	19.29	14.58
42	7.32	16.28	8.56	42	4.27	19.33	15.06
43	7.35	16.25	8.50	43	4.24	19.36	15.12
44	7.39	16.21	8.42	44	4.20	19.40	15.20
45	7.43	16.17	8.34	45	4.16	19.44	15.28
46	7.47	16.13	8.26	46	4.12	19.48	15.36
47	7.51	16.09	8.18	47	4.08	19.52	15.44
48	7.55	16.05	8.10	48	4.04	19.56	15.52
49	8.00	16.00	8.00	49	3.59	20.01	16.02
50	8.04	15.56	7.52	50	3.55	20.05	16.10
51	8.09	15.51	7.42	51	3.50	20.10	16.20
52	8.15	15.45	7.30	52	3.44	20.16	16.32
53	8.20	15.40	7.20	53	3.39	20.21	16.42
54	8.27	15.33	7.06	54	3.32	20.28	16.56
55	8.33	15.27	6.54	55	3.26	20.34	17.08
56	8.40	15.20	6.40	56	3.19	20.41	17.22
57	8.48	15.12	6.24	57	3.11	20.49	17.38
58	8.56	15.04	6.08	58	3.03	20.57	17.54
59	9.05	14.55	5.50	59	2.54	21.06	18.12
60	9.15	14.45	5.30	60	2.44	21.16	18.32

Sunset (true time or local apparent time) occurs the same number of hours after noon that sunrise happens before. An 0605 sunrise is 5 hours 55 minutes before noon, thus sunset is 5 hours 55 minutes after it, or 1755. Except for on the hour or half hour, the minutes do not match. For standard time, then the time is shifted by the longitude correction and then by the equation of time, thus the March and September equinoxes do not match due to differing EOT values.

APPENDIX 8 - COLLECTION OF FORMULAE INCONSISTENCIES AND APPARENT INCONSISTENCIES FORMULAE CONVERTED FOR A SPREADSHEET

SUNS DECLINATION FOR ANY GIVEN DAY OF THE YEAR

Day number, J J=1 on 1 January, J=365 on 31 December. February is taken to have 28 days.

<i>Jan</i>	<i>Feb</i>	<i>Mar</i>	<i>Apr</i>	<i>May</i>	<i>Jun</i>
0	31	59	90	120	151
<i>Jly</i>	<i>Aug</i>	<i>Sep</i>	<i>Oct</i>	<i>Nov</i>	<i>Dec</i>
181	212	243	273	304	334

Day angle: $da = 2 * \pi * (j-1) / 365$ (in radians, is an intermediate figure)

Sun Declination: $decl = \text{degrees} (0.006918 - 0.399912 * \cos(da) + 0.070257 * \sin(da) - 0.006758 * \cos(2 * da) + 0.000907 * \sin(2 * da) - 0.002697 * \cos(3 * da) + 0.001480 * \sin(3 * da))$

SUNS ALTITUDE AND AZIMUTH ON ANY GIVEN HOUR GIVEN THE SUNS DECLINATION

ALTITUDE: The sun's altitude is its angle when looked at face on in degrees
 $alt = \text{degrees} (\text{ASIN} (\text{SIN}(decl) * \text{SIN}(lat) + \text{COS}(decl) * \text{COS}(lat) * \text{COS}(lha)))$

The suns azimuth: $azi = \text{ATAN} (\text{SIN}(lha) / (\text{SIN}(lat) * \text{COS}(lha) - \text{COS}(lat) * \text{TAN}(decl)))$

SUNRISE AND SUNSET TIME FORMULA

Azimuth of rising/setting sun: $A = 180 - \arccos (\sin(decl) / \cos(lat))$
 Hour angle of rising/setting sun: $hsr = \arccos (\tan(lat) * \tan(decl))$ from noon

HORIZONTAL DIAL HOUR LINE ANGLE

$$H = \text{atan} (\sin(lat) * \tan (lha))$$

EQUATION OF TIME

A formula derived from Frans Maes from data by Savoie producing the EOT in minutes and using two sine waves is used for some spreadsheets, e.g. A2.1b, A2.1c. The values in the sin(...) function result in radians, so the formula is spreadsheet ready as-is. Value d = 1 to 365

$$E = -7.36 * \sin(2 * 3.1416 * (d-4.21) / 365) + -9.92 * \sin(4 * 3.1416 * (d-9.9) / 365)$$

STANDARD TIME FROM LAT (Local Apparent Time)

$$\begin{aligned} \text{legal time} &= \text{LAT} & + \text{EOT.corr} & + \text{west.long.corr} & + 1 \text{ if summer} \\ \text{or standard} && & - \text{east.long.corr} & \\ \text{time} && & & \end{aligned}$$

A DRAFTING SHEET FOR HORIZONTAL DIALS

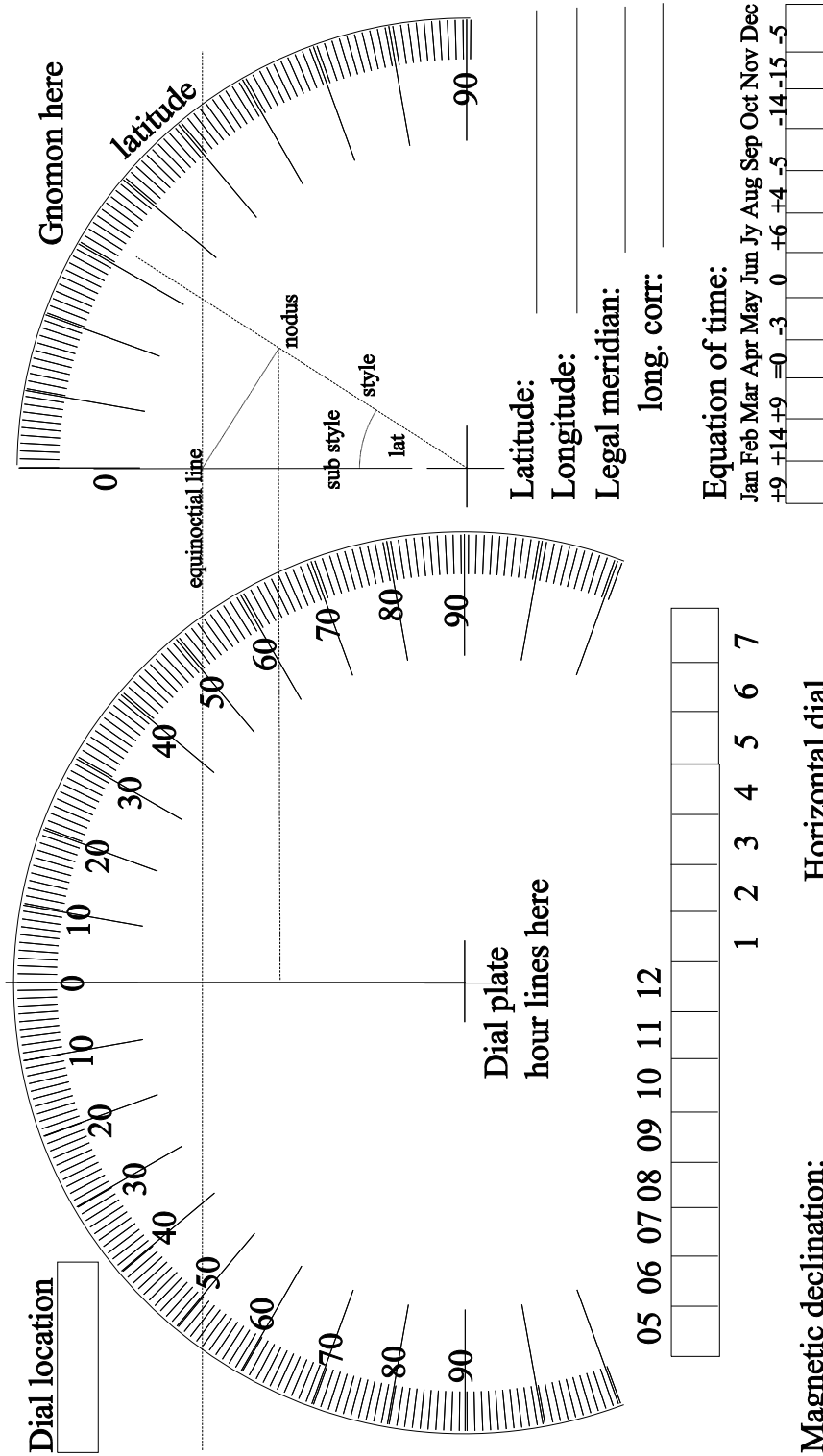

This template may be copied provided credit is given to Illustrating Shadows, www.illustratingshadows.com and Simon Wheaton-Smith

TECHNICAL TERMS

- equinox when the night duration is the same as the day, and this is March 21 and September 21, or 23, or whatever. Every day on the equator is one!
- solstice the shortest day or the longest day, December 21 and June 21 approximately.
- declination sun: it is the angle above or below the equator, ranging from -23.5° to $+23.5^{\circ}$
- declination magnetic: what aviators and mariners call variation, this is how far off true north the magnetic north pole is
- declination wall: how far off true south or true north a wall is, a vertical sundial facing true southwest would be S 45° W and have a declination of 45 degrees west. We must be very specific about the walls declination angle when we construct formulae.

When developing formulas, it may be more expedient to use an angle of 30° rather than 60° , not because of the size, but because that angle may simplify the math in the formulas, and thus reduce the chances of errors.

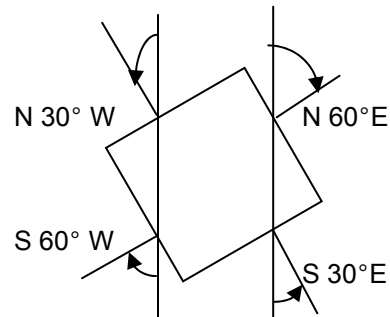

The measurement is made assuming you are standing with your back to the wall, from south, or from north, to the direction you are facing.

- variation is what mariners and aviators call the variation from true north of magnetic north, dialists call this declination.
- deviation over and above magnetic variation (or declination) the displacement of magnetic north due to local magnetic materials
- dialist: a person who practices gnomics or gnomonics
- gnomics: the study of sun dials
- Ø common symbol for latitude
- ° common symbol for degrees of arc

Some of the author's demonstration sun dials

THE DIFFERING SUN DIAL TYPES

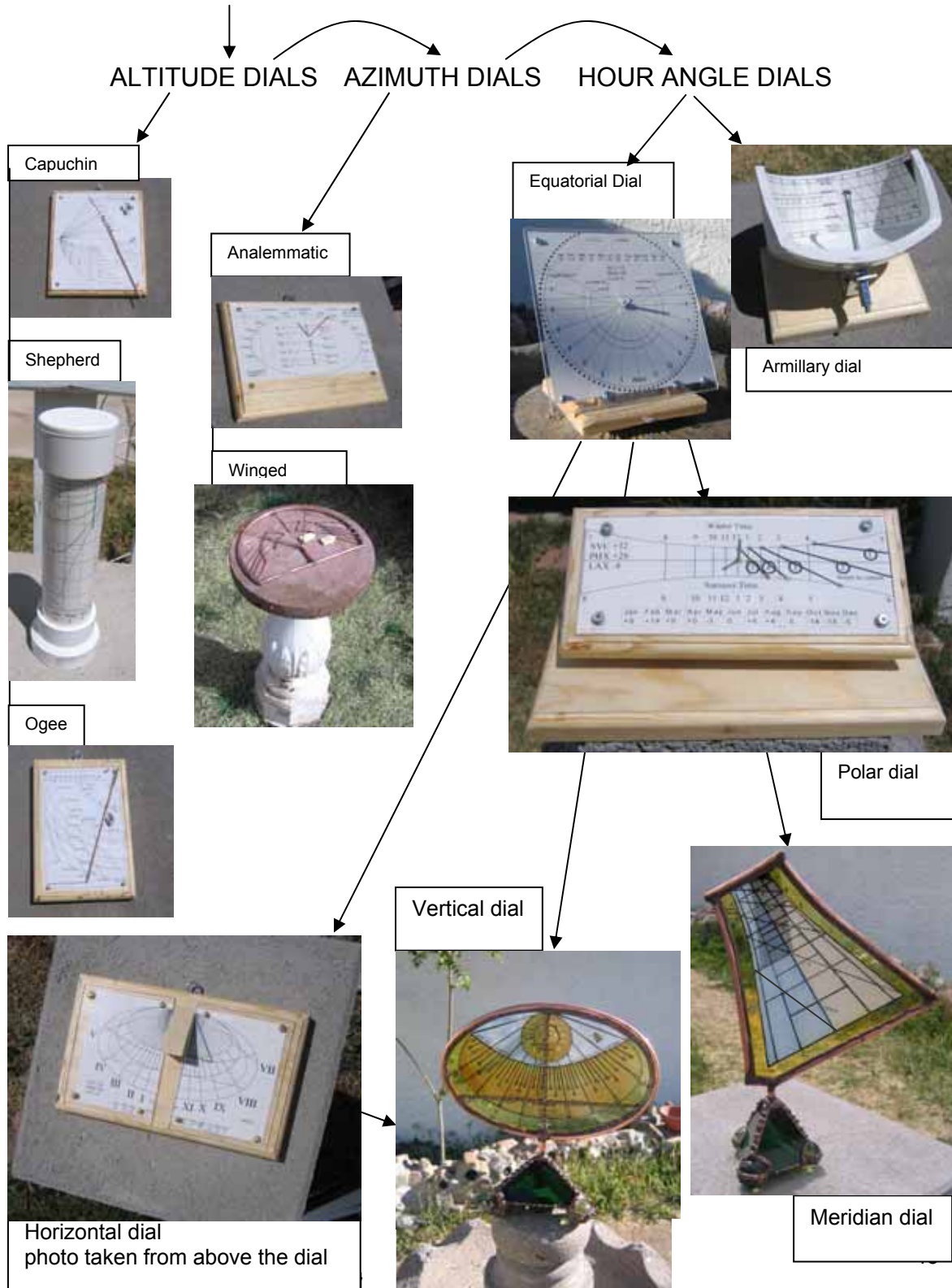

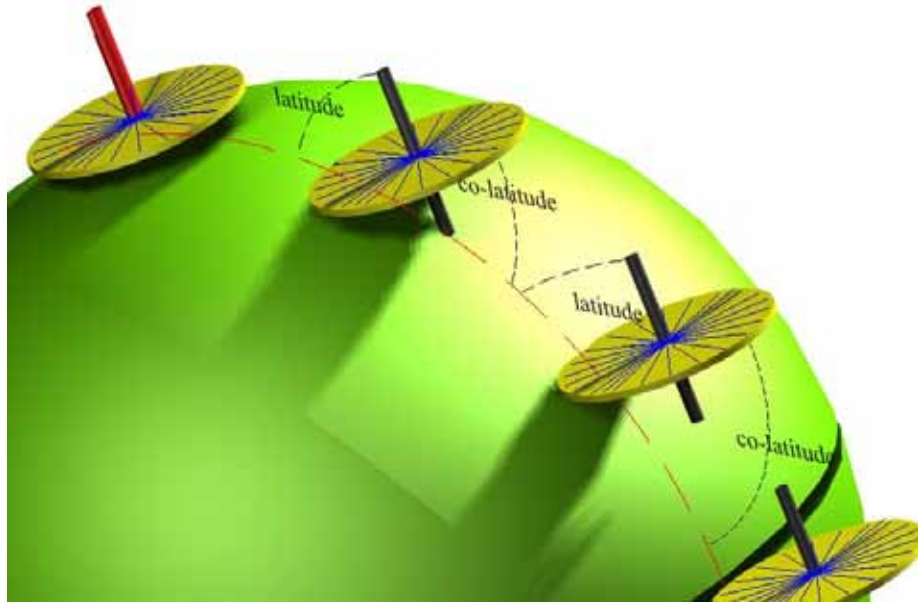

The equatorial dial at various latitudes

How the equatorial dial tilted at co-latitude draws horizontal dials, the sun is top left, the earth bottom right, and the dials in the middle.

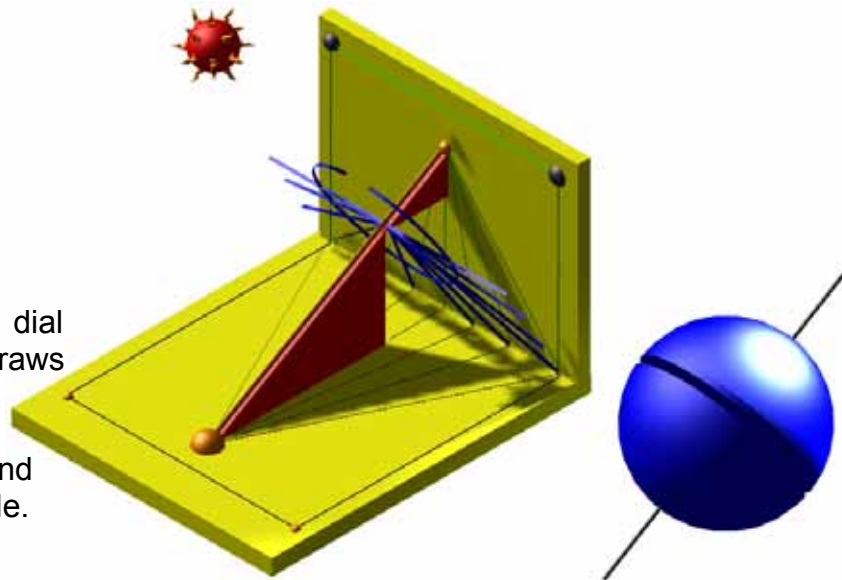

Please consider acquiring "ILLUSTRATING TIME'S SHADOW" ~ How to make Sundials for almost anywhere using empirical, geometric, and trigonometric methods as well as computer aided design and spreadsheets.

Simple Shadows

How to make a simple horizontal sun dial
Simon Wheaton-Smith

ISBN 0-9765286-5-7 ISBN13 978-0-9765286-5-4